

Self Diagnosis
Supported model

SERVICE MANUAL

BE-3E CHASSIS

MODEL	COMMANDER	CHASSIS NO.	MODEL	COMMANDER	CHASSIS NO.
KV-32FX20A	RM-887	SCC-Q22B-A	KV-32FX20E	RM-887	SCC-Q24B-A
KV-32FX20B	RM-887	SCC-Q23B-A	KV-32FX20U	RM-887	SCC-Q25B-A
KV-32FX20D	RM-887	SCC-Q21B-A			



TRINITRON® COLOR TV
SONY®



ITEM MODEL	Television System	Stereo System	Channel Coverage	Color System
Italian	B/G/H	GERMAN Stereo	ITALIA VHF : A-H2 (C) UHF : 21-69 PAL B/G/H VHF : E2-E12 UHF : E21-E69 CABLE TV (1) : S1-S41 CABLE TV (2) : S01-S05,M1-M10,U1-U10	PAL, SECAM NTSC4.43, NTSC3.58 (VIDEO IN)
French	B/G/H, D/K,L,I	GERMAN/NICAM Stereo	L VHF : F02-F10 UHF : F21-F60 CABLE : B-Q B/G/H VHF : E2-E12 UHF : E21-E69 CABLE TV (1) : S1-S41 CABLE TV (2) : S01-S05, M1-M10, U1-U10 ITALIA VHF : A-H2 (C) UHF : 21-69 I UHF : B21-B69	PAL, SECAM NTSC4.43, NTSC3.58 (VIDEO IN)
AEP	B/G/H	GERMAN Stereo	PAL B/G/H/ VHF : E2-E12 : E21-E69 CABLE TV (1) : S1-S41 CABLE TV (2) : S01-S05, M1-M10, U1-U10 ITALIA VHF : A-H2 (C) UHF : 21-69	PAL, SECAM NTSC4.43, NTSC3.58 (VIDEO IN)
Spanish	B/G/H, D/K	GERMAN/NICAM Stereo	PAL B/G/H/ VHF : E2-E12 : E21-E69 CABLE TV (1) : S1-S41 CABLE TV (2) : S01-S05, M1-M10, U1-U10 ITALIA VHF : A-H2 (C) UHF : 21-69	PAL, SECAM NTSC4.43, NTSC3.58 (VIDEO IN)
UK	I	NICAM Stereo	UHF : B21-B69	PAL NTSC4.43, NTSC3.58 (VIDEO IN)

MODEL	32FX20A	32FX20B	32FX20D	32FX20E	32FX20U
Power Consumption	106W	120W	120W	120W	176W

[PICTURE TUBE] FD Trinitron Wide
Approx. 82 cm (32 inches)
(Approx. 76 cm picture measured diagonally)
102 degree deflection

Input/Output Terminals

[REAR]

- 1 21-pin Euro connector (CENELEC standard).
 - Inputs for Audio and Video signals.
 - Inputs for RGB.
 - Outputs of TV Video and Audio signals.
- ↔ 2 / → S 2 21-pin Euro connector
 - Inputs for Audio and Video signals.
 - Inputs for S video.
 - Outputs for Video and Audio signals (selectable).
- ↻ Phono jacks
 - Outputs for Audio Signals

[FRONT]

- 3 Video output - phono jack
- ↻ 3 Audio inputs - phono jacks
- S S Video input - 4 pin din
- ↻ Headphone jack : stereo minijack

Sound output	2x20W (Music Power)
Subwoofer	20W (Music Power)
Power requirements	220 - 240V
Dimensions	Approx 874x563x571mm (w/h/d)
Weight	Approx 62kg
Supplied accessories	RM-887 Remote Commander (1) IEC designated R6 batteries (2)
Other features	NICAM*, FASTTEXT, TOPTTEXT * (KV-32FX20B, 32FX20E, 32FX20U)

[RM-887]

Remote control system	Infrared control
Power requirements	3V dc 2 batteries IEC designation R6 (size AA)
Dimensions	Approx 44x209x23mm (w/h/d)
Weight	Approx 89g (Not including battery)

Design and specifications are subject to change without notice.

Model Name	KV-32FX20A	KV-32FX20B	KV-32FX20D	KV-32FX20E	KV-32FX20U
Item					
Pal Comb	OFF	OFF	OFF	OFF	OFF
PIP	OFF	OFF	OFF	OFF	OFF
RGB Priority	OFF	OFF	OFF	OFF	OFF
Woofer Box	ON	ON	ON	ON	ON
Scart 1	ON	ON	ON	ON	ON
Scart 2	ON	ON	ON	ON	ON
Front in (3)	ON	ON	ON	ON	ON
Scart 4	OFF	OFF	OFF	OFF	OFF
Projector	OFF	OFF	OFF	OFF	OFF
AKB in 16:9 mode	ON	ON	ON	ON	ON
Norm B/G	ON	ON	ON	ON	OFF
Norm I	OFF	ON	OFF	OFF	ON
Norm D/K	OFF	ON	OFF	ON	OFF
Norm AUS	OFF	OFF	OFF	OFF	OFF
Norm L	OFF	ON	OFF	OFF	OFF
Norm SAT	OFF	OFF	OFF	OFF	OFF
Norm M	OFF	OFF	OFF	OFF	OFF
Teletext	ON	ON	ON	ON	ON
Nicam Stereo	OFF	ON	OFF	ON	ON
Language Preset	Italian	French	German	Spanish	English

WARNING (KV-32FX20U only)

The flexible mains lead is supplied connected to a **B.S. 1363** fused plug having a fuse of **5 AMP** capacity. Should the fuse need to be replaced, use a **5 AMP FUSE** approved by **ASTA to BS 1362**, ie one that carries the  mark.

IF THE PLUG SUPPLIED WITH THIS APPLIANCE IS NOT SUITABLE FOR THE OUTLET SOCKETS IN YOUR HOME, IT SHOULD BE CUT OFF AND AN APPROPRIATE PLUG FITTED. THE PLUG SEVERED FROM THE MAINS LEAD MUST BE DESTROYED AS A PLUG WITH BARED WIRES IS DANGEROUS IF ENGAGED IN A LIVE OUTLET SOCKET.

When an alternative type of plug is used it should be fitted with a **5 AMP FUSE**, otherwise the circuit should be protected by a **5 AMP FUSE** at the distribution board.

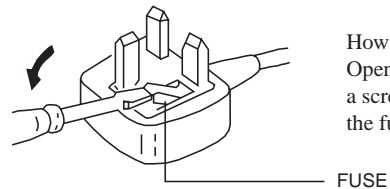

How to replace the fuse.
Open the fuse compartment with a screwdriver blade and replace the fuse.

21 pin connector (→ 1, ↔ 2/ → S 2)

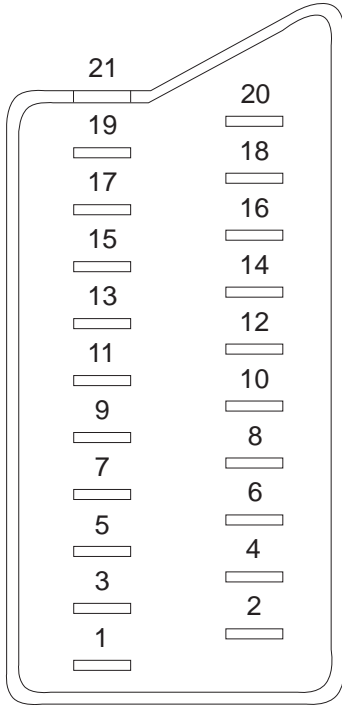
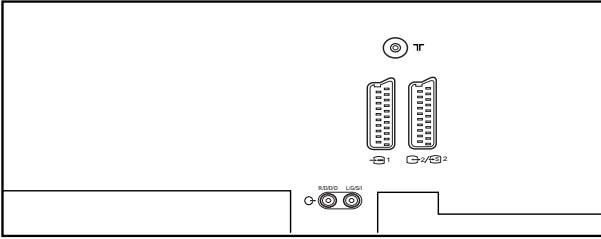

Pin No	1	2	4	Signal	Signal level
1	○	○	○	Audio output B (right)	Standard level : 0.5V rms Output impedance : Less than 1kohm*
2	○	○	○	Audio output B (right)	Standard level : 0.5V rms Output impedance : More than 10kohm*
3	○	○	○	Audio output A (left)	Standard level : 0.5V rms Output impedance : Less than 1kohm*
4	○	○	○	Ground (audio)	
5	○	○	○	Ground (blue)	
6	○	○	○	Audio input A (left)	Standard level : 0.5V rms Output impedance : More than 10kohm*
7	○	●	●	Blue input	0.7 +/- 3dB, 75 ohms positive
8	○	○	○	Function select (AV control)	High state (9.5-12V) : Part mode Low state (0-2V) : TV mode Input impedance : More than 10K ohms Input capacitance : Less than 2nF
9	○	○	○	Ground (green)	
10	○	○	○	Open	
11	○	●	●	Green	Green signal : 0.7 +/- 3dB, 75 ohms, positive
12	○	○	○	Open	
13	○	○	○	Ground (red)	
14	○	○	○	Ground (blanking)	
15	○	-	-	Red input	0.7 +/- 3dB, 75 ohms, positive
	-	○	○	(S signal Chroma input)	0.3 +/- 3dB, 75 ohms, positive
16	○	●	●	Blanking input (Ys signal)	High state (1-3V) Low state (0-0.4V) Input impedance : 75 ohms
17	○	○	○	Ground (video output)	
18	○	○	○	Ground (video input)	
19	○	○	○	Video output	1V +/- 3dB, 75ohms, positive sync 0.3V (-3+10dB)
20	○	-	-	Video input	1V +/- 3dB, 75ohms, positive sync 0.3V (-3+10dB)
	-	○	○	Video input Y (S signal)	1V +/- 3dB, 75ohms, positive sync 0.3V (-3+10dB)
21	○	○	○	Common ground (plug, shield)	

○ Connected ● Not Connected (open) * at 20Hz - 20kHz

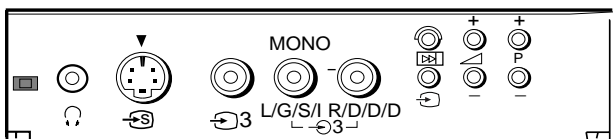

Pin No.	Signal	Signal Level
1	Ground	
2	Ground	
3	Y (S signal) input	1V ± 3dB 75 ohm, positive Sync. 0.3V -3 + 10dB
4	C (S signal) input	0.3V ± 3dB 75 ohm, positive Sync.

TABLE OF CONTENTS

<i>Section</i>	<i>Title</i>	<i>Page</i>	<i>Section</i>	<i>Title</i>	<i>Page</i>
	Warning and Caution3	4. CIRCUIT ADJUSTMENTS		
	Self-Diagnostic Function6			
1. GENERAL			4-1.	Electrical Adjustments24
	Overview of the Remote Control Buttons10	4-2.	'TT' Test Mode27
	Adjusting the Picture12	4-3.	'T' Test Mode28
	Adjusting the Sound12	5. DIAGRAMS		
	Teletext13	5-1.	Block Diagrams (1)29
	Troubleshooting14		Block Diagrams (2)33
2. DISASSEMBLY			5-2.	Circuit Board Location36
	2-1. Rear Cover Removal15	5-3.	Schematic Diagrams and Printed Wiring Boards36
	2-2. Chassis Assy Removal15		* C Board37
	2-3-1. Service Position (1)15		* D Board43
	2-3-2. Service Position (2)15		* D2 Board46
	2-4. Wire Dressing16		* VM Board47
	2-5. A Board Removal16		* H Board51
	2-6. A Extension Board16		* A Board59
	2-7. Picture Tube Removal17		* D1 Board64
	Removal and Replacement of the Main - Bracket Bottom Plates18	5-4.	Semiconductors69
			5-5.	IC Blocks71
3. SET-UP ADJUSTMENTS			6. EXPLODED VIEWS		
	3-1. Beam Landing19	6-1.	Chassis73
	3-2. Convergence20	6-2.	Picture Tube74
	3-3. Screen G222	7. ELECTRICAL PARTS LIST	75
	3-4. Focus22			
	3-5. White Balance23			

CAUTION

SHORT CIRCUIT THE ANODE OF THE PICTURE TUBE AND THE ANODE CAP TO THE METAL CHASSIS, CRT SHIELD, OR THE CARBON PAINTED ON THE CRT, AFTER REMOVAL OF THE ANODE CAP

WARNING !!

AN ISOLATING TRANSFORMER SHOULD BE USED DURING ANY SERVICE WORK TO AVOID POSSIBLE SHOCK HAZARD DUE TO LIVE CHASSIS. THE CHASSIS OF THIS RECEIVER IS DIRECTLY CONNECTED TO THE POWER LINE.

SAFETY-RELATED COMPONENT WARNING !!

COMPONENTS IDENTIFIED BY SHADING AND MARKED Δ ON THE SCHEMATIC DIAGRAMS, EXPLODED VIEWS AND IN THE PARTS LIST ARE CRITICAL FOR SAFE OPERATION. REPLACE THESE COMPONENTS WITH SONY PARTS WHOSE PART NUMBERS APPEAR AS SHOWN IN THIS MANUAL OR IN SUPPLEMENTS PUBLISHED BY SONY.

ATTENTION

APRES AVOIR DECONNECTE LE CAP DE L'ANODE, COURT-CIRCUITER L'ANODE DU TUBE CATHODIQUE ET CELUI DE L'ANODE DU CAP AU CHASSIS METALLIQUE DE L'APPAREIL, OU AU COUCHE DE CARBONE PEINTE SUR LE TUBE CATHODIQUE OU AU BLINDAGE DU TUBE CATHODIQUE.

ATTENTION !!

AFIN D'EVITER TOUT RISQUE D'ELECTROCUTION PROVENANT D'UN CHÂSSIS SOUS TENTION, UN TRANSFORMATEUR D'ISOLEMENT DOIT ETRE UTILISÉ LORS DE TOUT DÉPANNAGE. LE CHÂSSIS DE CE RÉCEPTEUR EST DIRECTMENT RACCORDÉ À L'ALIMENTATION SECTEUR.

ATTENTION AUX COMPOSANTS RELATIFS À LA SÉCURITÉ !!

LES COMPOSANTS IDENTIFIÉS PAR UNE TRAME ET PAR UNE MARQUE Δ SUR LES SCHÉMAS DE PRINCIPE, LES VUES EXPLOSÉES ET LES LISTES DE PIÈCES SONT D'UNE IMPORTANCE CRITIQUE POUR LA SÉCURITÉ DU FONCTIONNEMENT, NE LES REMPLACER QUE PAR DES COMPOSANTS SONY DONT LE NUMÉRO DE PIÈCE EST INDIQUÉ DANS LE PRÉSENT MANUEL OU DANS DES SUPPLÈMENTS PUBLIÉS PAR SONY.

BE-3E SELF DIAGNOSTIC SOFTWARE

The errors indicated below can be read using an Error Reader Display (Part Number S-188-900-10) connected to the service connector. Once an error has been detected it will then be displayed on the two digit error reader. During the power up procedure and during normal run time, the micro's self diagnostic procedures monitor for various errors. Errors displayed refer to the table indicated below.

Error Number	Error Description
00	No error (TV Error Reader shows 00 in normal condition)
01	Not allowed (may be confused with Sircs response flash on LED)
02	Protection circuit trip (OCP, OVP & No V-Sync)
03	Reserved for OVP (Included in error 2 for BE-3E)
04	Reserved for No V-Sync (Included in error 2 for BE-3E)
05	AKB
06	IIC Scl Low <Power Up only>
07	IIC Sda Low <Power Up only>
08	IIC Sda & Scl Low <Power Up only>
09	Jungle controller no acknowledge <Power Up only>
10	Video Switch (CXA2040) no acknowledge <Power Up only>
11	Tuner no acknowledge
12	MSP no acknowledge
13	NVM no acknowledge
14	AV switch (CXA2089) no acknowledge (DS20 & DX20)
15	Not used
16	Port Expander (CXA1875) no acknowledge (DS20 & DX20)
17	Not used
18	Dynamic Convergence (CXA8070) no acknowledge
19	Cannot Initialise jungle (after initial power on check OK) - <Chassis Initialisation>
20	Jungle controller response failure after power up check (+9V test)
21	Video Switch (CXA2040) cannot power on reset - <Chassis Initialisation>
22	Video Switch (CXA2040) response failiure after power up check (+9V test)
23	NVM acknowledge fail after initialisation (STBY +5V - same as micro!)
24	MSP run-time failure <May Not Be Fatal - Display On Error Reader>
25	DSP run-time failure <May Not Be Fatal - Display On Error Reader>
26	M3L bus Clock low time out after data send <Run-Time Failure>
27	M3L bus Clock low time out after data send <At Power Up Check>
28	M3L bus Clock low time out after data send <At Initialisation>
29	M3L Txd Low <Power Up Only>
30	M3L Rxd Low <Power Up Only>
31	M3L Enable Low <Power Up Only>
32	Compact Text test fail <Power Up Only>
33	Compact Text does not respond (+5V test)
34	Compact text run-time failure <May Not Be Fatal - Display On Error Reader>

Protection Error (Error 2):

Once every main loop (approximately 200ms OSD mode, 50ms text or menu mode), the micro checks the protection pin (pin 66). If the protection pin is high 6 successive times, a protection error is diagnosed. The protection pin is **not** checked during the first 3 - 4 seconds after AC on.

If this error is diagnosed, the respective NVM register will be updated and the set goes straight into diagnostic standby with 2 flashes - no reset is attempted.

AKB Error (Error 5):

Once every main loop the micro checks the AKB stability by reading the IKR return from the Jungle IC. IKR=1 means that the AKB is stable, IKR=0 means that the AKB is unstable. If the AKB status is unstable for 10 seconds, an AKB error is diagnosed. AKB stability is not checked during the first 20 seconds after AC switch on.

If this error is diagnosed, the respective NVM register will be updated and the response LED will flash 5 times continually, but the set will not go into standby mode. If the AKB status becomes stable, and remains stable for 10 seconds, the LED will stop flashing.

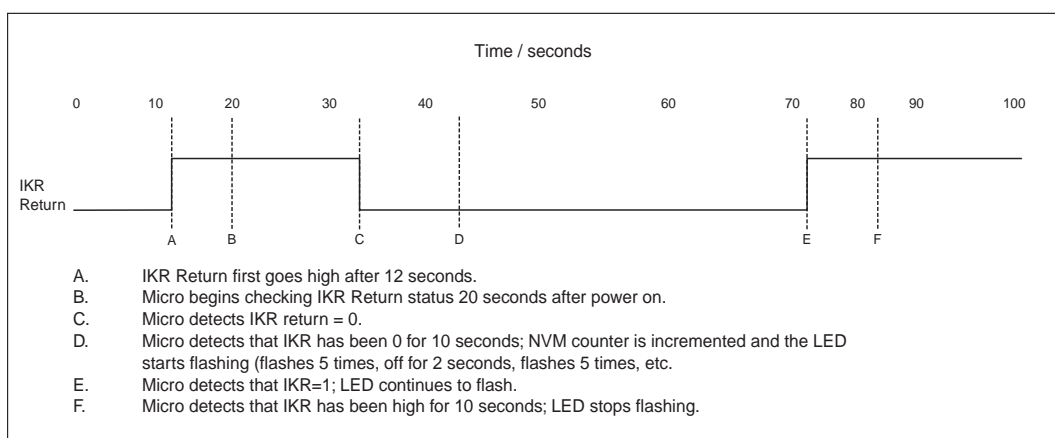

Startup Diagnostic Errors (Errors 6-18, 27, 29-32):

NVM	Error Description
6	SCL pin low
7	SDA pin low
8	Both SCL and the SDA pins are low
9	No acknowledge from the jungle (CXA2076)
10	No acknowledge from the video switch (CXA2040)
11	No acknowledge from the tuner
12	No acknowledge from the MSP
13	No acknowledge from the NVM
14	No acknowledge from the CXA2089 video switch (DS20 & DX20)
16	No acknowledge from the CXA1875 video Port Expander (DS20 & DX20)
18	No acknowledge from the Dynamic Convergence (CXA8070)
27	M3L_TXD pin low after Compact Text RAM test.
29	M3L_TXD pin low
30	M3L_RXD pin low
31	M3LEN pin low
32	Compact Text RAM test fail

If any of these errors are detected, the respective NVM register will be incremented. The software will then carry on with the power up sequence.

General IIC Device Run-time Errors (Errors 19-23):

NVM	Error Description
19	No acknowledge from Jungle when attempting to initialise.
20	No acknowledge from Jungle when attempting to read registers.
21	AV Switch cannot complete reset during initialisation.
22	No acknowledge from AV Switch when attempting to read registers.
23	No acknowledge from NVM when attempting to read or write.

If any of these errors are detected, the respective NVM register will be incremented and the software will carry on.

Compact Text Run-time Errors (Errors 26, 28, 33 & 34):

NVM	Error Description
26	M3L_TXD pin low when checking register 81 (implies that no communication was possible).
28	M3L_TXD pin low when attempting to initialise (implies that no communication was possible).
33	Compact Text RAM test failed during initialisation of devices.

In the case of these errors, the 'device reset' pin will be held low for 60ms, causing a hardware reset of Compact Text. Following this reset, a longer timeout will be allowed for the M3L bus to recover. If the error still exists, the NVM register will be incremented and the software will carry on.

NVM	Error Description
34	Register 81 check fail, but M3L_TXD pin high (implies that Compact Text has either reset or become corrupted).

In the case, the 'device reset' pin will be held low for 60ms, causing a hardware reset of Compact Text. Compact Text will then be re-initialised and the NVM counter updated. This is the same as for errors 26, 28 and 33 except that the M3L bus timeout is not changed.

MSP and DSP Run-time Errors (Errors 24 & 25):

NVM	Error Description
24	Error 24 can be caused by any of the following : - After MSP initialisation, Scart Prescale Register check fail (implies that the MSP has either reset or become corrupted). - MSP fails to acknowledge reset instruction. - Scart Prescale Register check fail (implies that the MSP has either reset or become corrupted).
25	- DSP test byte corrupted (implies that the MSP has either reset or become corrupted).

For both these errors, the software will refresh the MSP and DSP registers. If the errors still exist, the NVM counter will be incremented, and the software will carry on.

Error Display Mode

Error Display Mode is entered by the following sequence of commands :

Standby -> Information -> Digit 5 -> Volume Down -> TV

This mode will display a special menu, which will list all possible errors and the number of occurrences of each error (0 - 255, as stored in the NVM). There will also be a display of the current error (00 if no error). This display mode will appear as follows :

ERROR DISPLAY MODE			
Current Error Code = 00			
Error Code	Occurrences	Error Code	Occurrences
2	2	19	0
3	--	20	0
4	--	21	0
5	0	22	0
6	0	23	0
7	0	24	0
8	0	25	4
9	0	26	5
10	0	27	89
11	0	28	3
12	0	29	0
13	0	30	0
14	0	31	0
15	3	32	0
16	0	33	3
17	0	34	38
18	6		

Whilst in this mode, the number of occurrences of each error can be reset to 0 by following sequence of Sircs commands: Digit 8 -> Digit 0. 'TT08' will also reset this NVM data.

This mode can only be exited by switching off the TV.

The Current Error Code can also be read by using a TV Error Reader (IIC slave address 42H). This device simply receives 1 data byte, which is the error number in binary coded decimal form.

SECTION 1 GENERAL

The operating instructions mentioned here are partial abstracts from the Operating Manual. The page numbers of the Operating Instruction Manual remain as in the manual.

Overview

Overview of the remote control buttons

To mute sound

Press to mute TV sound. Press again to restore the sound.

To reveal on screen information

Press to reveal all on-screen indications. Press again to cancel.

To select channels

Press the numbered buttons to select channels.

For double digit programme numbers, e.g.23, press **-/-** first, then the buttons 2 and 3.

If you enter an incorrect first digit, this should be corrected by entering another digit (0 - 9) and then selecting **-/-** button again to enter the programme number of your choice.

To return to TV mode

Press to return to the normal operation from teletext mode or standby mode.

To select teletext

Press to switch on Teletext.

To display sound menu

Press to change the sound settings. Press again to remove the display.

To display picture menu

Press to change the picture settings. Press again to remove the display.

To adjust TV volume

Press to adjust the volume of the TV.

To temporarily switch off TV

Press to temporarily switch off TV. Press again to switch on TV from standby mode.

To save energy we recommend switching off completely when TV is not in use.

NOTE: After 15 -30 minutes without a TV signal and without any button being pressed, the TV switches automatically into standby mode.

To select input signal or freeze teletext

Press to select inputs from the TV sockets (see Using Optional Equipment section). In teletext mode, press to freeze the displayed page. Press once again to cancel.

To return to previous channel

Press to return to the previous channel you were watching. Note: This can be done only after watching the present channel for 5 seconds

To display the menu

Press if you wish to use the TV menu system. Press again to remove the menu from the TV screen.

To select menu items

Use the OK button and arrow keys to select the options available in the menu system of this TV.

To change screen format

Press to change the size of the screen.

This button has no function

To select channels

Press to select channels.



Quick Start Guide

6. Automatically tuning the TV

When you first switch on the TV, the following sequence of menu screens appear on the TV enabling you to 1) choose a language for the TV menu screens, 2) add channels to the TV, 3) arrange the channels.

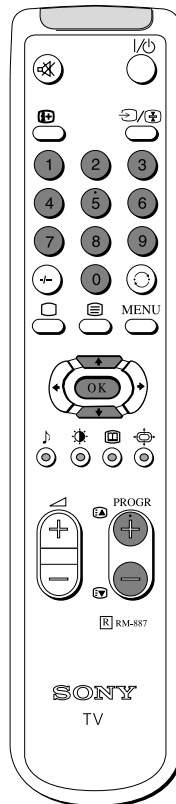

1 When switching on the TV for the first time, the 'LANGUAGE' menu appears automatically on the TV screen enabling you to select in which language you wish to read the TV menu screens. Press the UP and DOWN arrow keys on the remote control to select your language then press the OK button to confirm your selection.

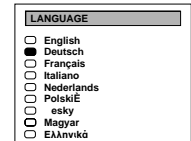

2 The 'AUTO TUNE' menu appears on the TV screen in your selected language. Press the UP and DOWN arrow keys to select 'YES' then press the OK button to confirm.

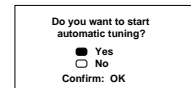

3 A new menu appears asking you to check that the antenna is connected. Ensure that the antenna is connected then press the OK button to confirm. The TV now starts to automatically search and store all available channels for you. Please be patient and do not press any buttons.

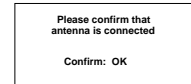

4 When the TV has finished tuning in all available channels, the 'PROGRAMME SORTING' menu appears on the TV screen which enables you to change the channel order on your TV. If you wish to change the order of any of the TV channels, press the PROGR +/- button on your remote control until the channel you wish to rearrange appears on the screen. Press the UP or DOWN arrow keys to select the new programme number position for your selected channel. Press the OK button to confirm. Repeat this procedure if you wish to change the order of other channels on your TV.

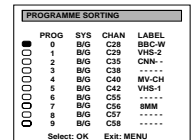
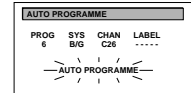

5 Press the MENU button to remove the menu from the TV screen.

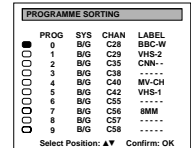



6 Press the PROGR +/- or the numbered buttons on the remote control to view the TV channels.

Additional TV Features

Choosing a language for the TV menu screens

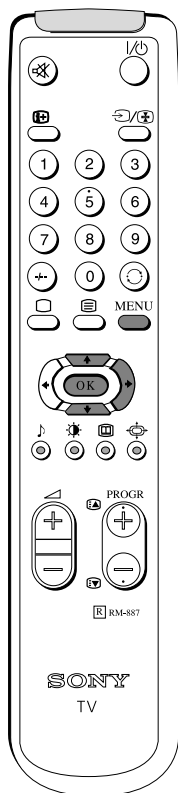
The TV consists of a menu system which can appear on screen in a variety of languages. Use the following feature to select the language that best suits you.



- 1 Press the MENU button on the remote control to display the menu on the TV screen.
- 2 Press the UP or DOWN arrow keys to select the  symbol on the menu screen then press the RIGHT arrow key to enter the 'PRESET' menu
- 3 Press the UP or DOWN arrow keys to select 'Language' on the menu screen then press the RIGHT arrow key to enter the 'LANGUAGE' menu.
- 4 Press the UP or DOWN arrow keys to select your chosen language.
- 5 Press the OK button to confirm your selection.
- 6 Press the MENU button to remove the display from the TV screen.

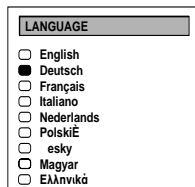
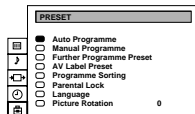
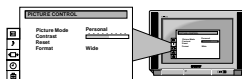

Additional TV Features

Re-arranging the TV channels

After automatically tuning the TV, you can use this feature to change the channel order. You may wish for example to exchange the channel on programme number 8 with the channel on programme number 4.

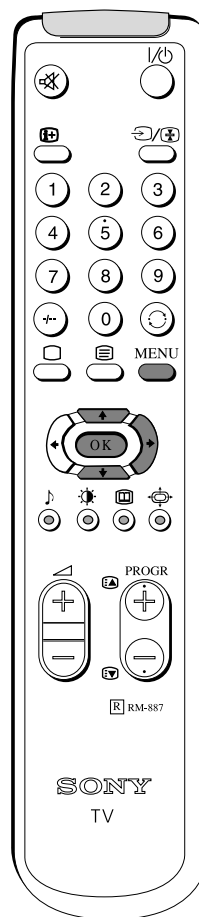

- 1 Press the MENU button on the remote control to display the menu on the TV screen.
- 2 Press the DOWN arrow key on the remote control to select the  symbol on the menu screen then press the RIGHT arrow key to enter the 'PRESET' menu.
- 3 Press the DOWN arrow key to select 'Programme Sorting' then press the RIGHT arrow key to enter the 'PROGRAMME SORTING' menu.
- 4 Press the UP or DOWN arrow keys to select the programme position of the channel you want to move (e.g. PROG 8) then press the OK button to confirm.
- 5 Press the UP or DOWN arrow keys to select the new programme position for your selected channel (e.g. PROG 4) then press the OK button to confirm. The two selected channels now exchange position.
- 6 Repeat steps 4 and 5 if you wish to sort other channels.
- 7 Press the MENU button to remove the menu from the TV screen.

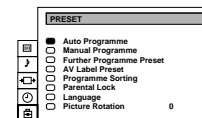

PROGRAMME SORTING			
PROG	SYS	CHAN	LABEL
0	BG	C28	BBC-W
1	BG	C29	VHS-2
2	BG	C35	CNN-
3	BG	C38	----
4	BG	C40	MV-CH
5	BG	C42	VHS-1
6	BG	C55	----
7	BG	C56	8MM
8	BG	C57	----
9	BG	C58	----

PROGRAMME SORTING			
PROG	SYS	CHAN	LABEL
0	BG	C28	BBC-W
1	BG	C29	VHS-2
2	BG	C35	CNN-
3	BG	C38	----
4	BG	C40	MV-CH
5	BG	C42	VHS-1
6	BG	C55	----
7	BG	C56	8MM
8	BG	C57	----
9	BG	C58	----

PROGRAMME SORTING			
PROG	SYS	CHAN	LABEL
0	BG	C28	BBC-W
1	BG	C29	VHS-2
2	BG	C35	CNN-
3	BG	C38	----
4	BG	C40	MV-CH
5	BG	C42	VHS-1
6	BG	C55	----
7	BG	C56	8MM
8	BG	C57	----
9	BG	C58	----

Adjusting the picture

Although the picture is adjusted at the factory, you can modify it to suit your own taste.

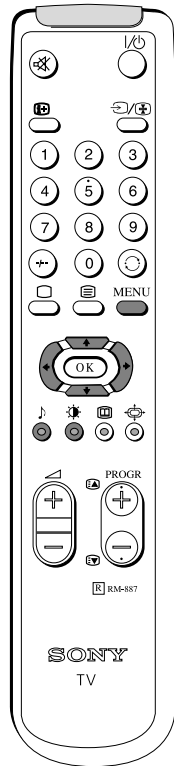

- 1 Press the MENU button on the remote control to display the menu on the TV screen.
- 2 Press the UP or DOWN arrow key on the remote control to select the symbol on the menu screen then press the RIGHT arrow key to enter the 'PICTURE CONTROL' menu.
- 3 Press the UP or DOWN arrow keys to select the item on the screen you wish to adjust then press the RIGHT arrow key to confirm. For a description of the menu items and their effects, see the table underneath.
- 4 If you selected 'Picture Mode' or 'Format' in step 3, press the UP or DOWN arrow keys to select the item on the screen you wish to adjust then press the RIGHT arrow key to confirm.
- 5 Press the RIGHT or LEFT arrow keys to adjust your selected item.
- 6 As soon as you have adjusted the item, press the OK button to store the new setting.
- 7 If you selected 'Picture Mode' or 'Format' in step 3, press the LEFT arrow key to return to the 'PICTURE CONTROL' menu.
- 8 Repeat steps 3-7 to adjust the other items.
- 9 Press the MENU button to remove the menu from the TV screen.

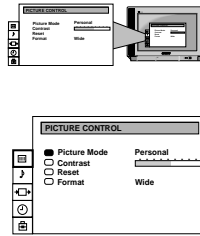

Picture Mode	Picture Mode	◆ Personal (for individual settings)
		◆ Movie (for films)
		◆ Live (for live broadcasts)
Brightness*	◆ Darker	◆ Brighter
Colour*	◆ Less	◆ More
Sharpness*	◆ Softer	◆ Sharper
Hue**	◆ Greenish	◆ Reddish
Contrast	◆ Less	◆ More
Reset	Resets picture to factory preset levels	
Format	Format	(refer to page 14 for details)
	Scroll	
	Auto 16:9	◆ Off ◆ On

* Only if you select 'Personal' in 'Picture Mode'.
 ** Available for NTSC colour system only.

Changing picture and sound modes quickly

You can quickly change the Picture Mode or the Equalizer Mode without entering the 'PICTURE CONTROL' or the 'SOUND CONTROL' menu screens.

- 1 Press the symbol on the remote control for picture modes or the symbol for equalizer modes.
- 2 Press the UP or DOWN arrow keys to select the desired mode.
- 3 Press or again to remove the display from the TV screen.

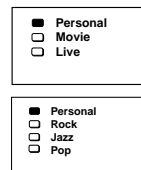

Adjusting the sound

Although the sound is adjusted at the factory, you can modify it to suit your own taste.

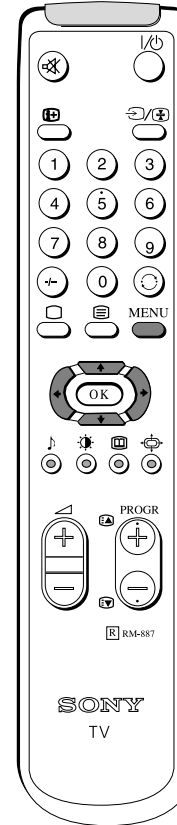

- 1 Press the MENU button on the remote control to display the menu on the TV screen.
- 2 Press the DOWN arrow key on the remote control to select the symbol on the menu screen then press the RIGHT arrow key to enter the 'SOUND CONTROL' menu.
- 3 Press the UP or DOWN arrow keys to select the item on the screen you wish to adjust then press the RIGHT arrow key to confirm. For a description of the menu items and their effects, see the table underneath.
- 4 If you selected 'Sound Mode' in step 3, press the UP or DOWN arrow keys to select the item on the screen you wish to adjust then press the RIGHT arrow key to confirm.
- 5 Press the RIGHT or LEFT arrow keys to adjust your selected item.
- 6 As soon as you have adjusted the item, press the OK button to store the new setting.
- 7 If you selected 'Sound Mode' in step 3, press the LEFT arrow key to return to the 'SOUND CONTROL' menu.
- 8 Repeat steps 3-7 to adjust the other items.
- 9 Press the MENU button to remove the menu from the TV screen.

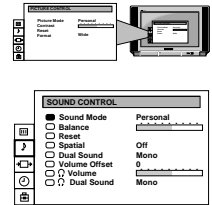

Sound Mode	◆ Personal ◆ Jazz ◆ Rock ◆ Pop
Balance	Less ◆ ◆ More
Reset	Resets picture to factory preset levels
Spatial	◆ On: volume level of the channels will stay the same ◆ Off: volume level changes according to the broadcast signal
Dual Sound	Stereo ◆ ◆ Mono (for a stereo broadcast) A for channel 1 ◆ ◆ B for channel 2 (for a bilingual broadcast)
Volume Offset	◆ The channel volume level can be adjusted over a range of -12 to +12
Headphones Volume Dual Sound	Less ◆ ◆ More Stereo ◆ ◆ Mono (for a stereo broadcast) A for channel 1 ◆ ◆ B for channel 2 (for a bilingual broadcast)

Additional TV Features

Manually fine tuning the TV picture

If the picture is distorted, you can manually fine-tune the TV to obtain a better picture reception.

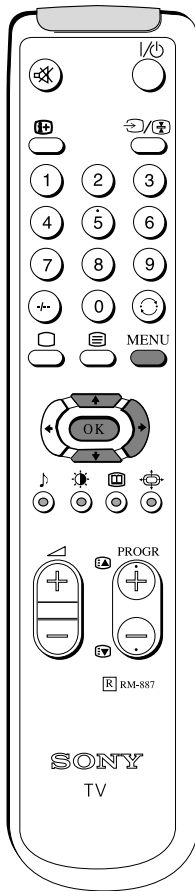

- 1 Press the MENU button on the remote control to display the menu on the TV screen.
- 2 Press the DOWN arrow key to select the symbol on the menu screen then press the RIGHT arrow key to enter the 'PRESET' menu.
- 3 Press the DOWN arrow key to select 'Further Programme Preset' then press the RIGHT arrow key to enter the 'FURTHER PROGRAMME PRESET' menu.
- 4 Press the UP or DOWN arrow keys to select the programme number you want to manually fine-tune.
- 5 Press the RIGHT arrow key repeatedly until the AFT column is highlighted.
- 6 Press the UP or DOWN arrow keys to fine tune the channel frequency over a range of -15 to +15.
- 7 Press the OK button to confirm.
- 8 Repeat steps 4 to 7 to fine-tune other channels.
- 9 Press the MENU button to remove the menu from the TV screen.

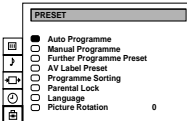
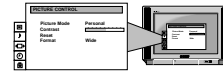

FURTHER PROGRAMME PRESET		
PROG	AFT	DECODER
0	On	Off
1	On	Off
2	On	AV1
3	On	Off
4	On	AV2
5	On	Off
6	On	Off
7	On	Off
8	On	Off
9	On	Off

FURTHER PROGRAMME PRESET		
PROG	AFT	DECODER
0	On	Off
1	On	Off
2	On	AV1
3	On	Off
4	On	AV2
5	On	Off
6	10	Off
7	On	Off
8	On	Off
9	On	Off

Teletext

Teletext

Teletext is an information service transmitted by most TV stations.

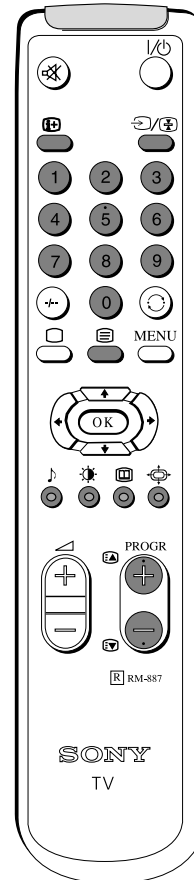

Switching Teletext on and off

- 1 When viewing channels, press a number button on the remote control to select the channel which carries the teletext service you wish to receive.
- 2 Press the button on the remote control to switch on teletext.
- 3 Input three digits for the page number using the numbered buttons on the control. If you make a mistake, type in any three digits then re-enter the correct page number.
- 4 Press the button to switch off teletext.

NOTE: Teletext errors may occur if the broadcasting signals are weak.

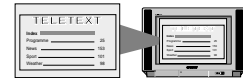

Using Other Teletext Functions

To superimpose teletext on to the TV

Press the button on the remote control once in teletext mode or twice in TV mode to superimpose teletext on to the TV screen.
Press button once more to cancel.



To Move to Next or Preceding Page

Press or on the control to select the previous or next page.



To Freeze a Teletext Page

Press on the control to freeze the page. Press again to cancel the freeze.

Revealing concealed information (eg: answers to a quiz).

Press to reveal information. Press again to conceal the information.

Using Fastext

(only available if the TV station broadcasts Fastext signals)
When the colour coded menu appears at the bottom of a page, press the colour button (green, red, yellow or blue) on the control to access the corresponding page.

Additional Information

Specifications

TV system

B/G/H

Colour system

PAL, SECAM
NTSC 3.58, 4.43 (only Video In)



Channel coverage

See 'Receivable Channels' table on next page





Picture tube

KV-28FX20D:
FD Trinitron WIDE
Approx. 71 cm (28 inches) (Approx. 66 cm picture measured diagonally),
102° deflection
KV-32FX20D:
FD Trinitron WIDE
Approx. 82 cm (32 inches) (Approx. 76 cm picture measured diagonally),
102° deflection

Rear Terminals

-  21-pin Euro connector (CENELEC standard) including audio/video input, RGB input
-  21-pin Euro connector (CENELEC standard) including audio/video input, S-video input, Monitor audio/video output
-  Audio outputs - phono jacks

Front Terminals

-  3 video input - phono jack
-  3 audio inputs - phono jacks
-  S video input - 4 pin DIN
-  Headphones jack - minijack stereo

Sound output:

Left, Right 2x20W (music power)
Subwoofer 20W (music power)

Power consumption

KV-28FX20D: 123 W
KV-32FX20D: 120 W

Dimensions (wxhxd)

KV-28FX20D: Approx. 761 x 496 x 525 mm
KV-32FX20D: Approx. 874 x 563 x 571 mm

Weight

KV-28FX20D: Approx. 44.0 kg
KV-32FX20D: Approx. 62.0 kg

Accessories supplied

RM-887 Remote Control (1)
IEC designated size AA battery (2)

Other features











TELETEXT

Design and specifications are subject to change without notice.

Additional Information

Troubleshooting

Here are some simple solutions to problems which may affect the picture and sound.

Problem	Solution
No picture (screen is dark), no sound	<ul style="list-style-type: none">• Plug the TV in.• Press the  button on the front of TV.• If the  indicator is on press  button or a programme number button on the remote control.• Check the aerial connection.• Check that the selected video source is on.• Turn the TV off for 3 or 4 seconds and then turn it on again using the  button on the front of the TV.
Poor or no picture (screen is dark), but good sound.	<ul style="list-style-type: none">• Using the MENU system, select the Picture Control and Picture Mode displays. Adjust the contrast, brightness, and colour levels.• From the Picture Control display select RESET to return to factory settings.
Poor picture quality when watching a RGB video source.	<ul style="list-style-type: none">• Press the  button repeatedly on the remote control until the RGB symbol  is displayed on the screen.
Good picture, no sound	<ul style="list-style-type: none">• Press the  +/- button on the remote control.• If  is displayed on the screen, press the  button on the remote control.
No colour on colour programmes	<ul style="list-style-type: none">• Using the MENU system, select the Picture Mode display. Adjust the the colour level setting.• From the Picture Control display select RESET to return to factory settings.
Distorted picture when changing programmes or selecting teletext	<ul style="list-style-type: none">• Turn off any equipment connected to the 21 pin Euro connectors on the rear of the TV.
Remote control does not function	<ul style="list-style-type: none">• Replace the batteries.
The standby indicator  on the TV flashes	<ul style="list-style-type: none">• Contact your nearest Sony service centre.

- If you continue to have these problems, have your TV serviced by qualified personnel.
- NEVER open the casing yourself.

SECTION 2 DISASSEMBLY

2-1. REAR COVER REMOVAL

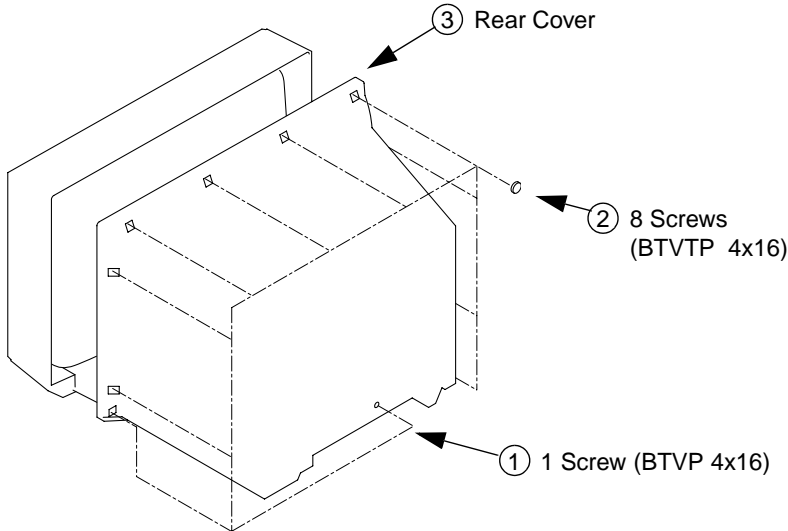

2-2. CHASSIS ASSY REMOVAL

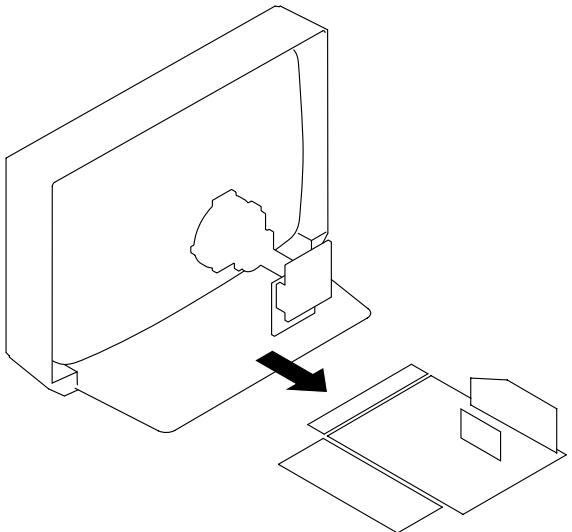

2-3-1. SERVICE POSITION (1)

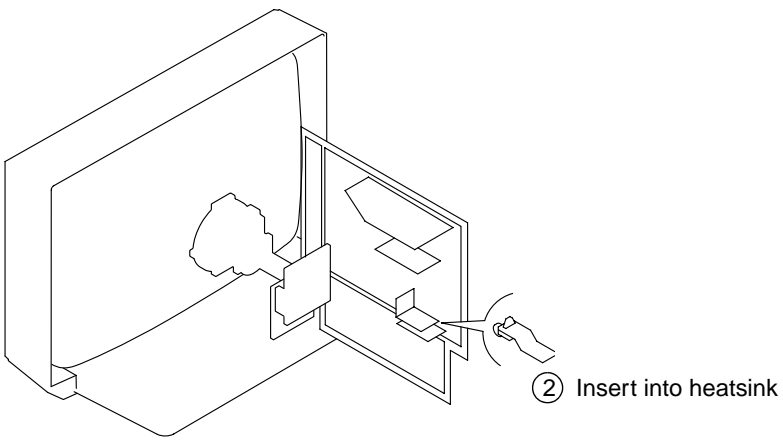

2-3-2. SERVICE POSITION (2)

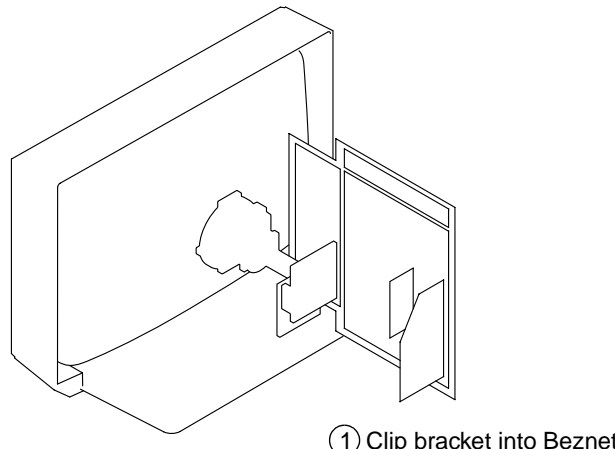

2-4. WIRE DRESSING

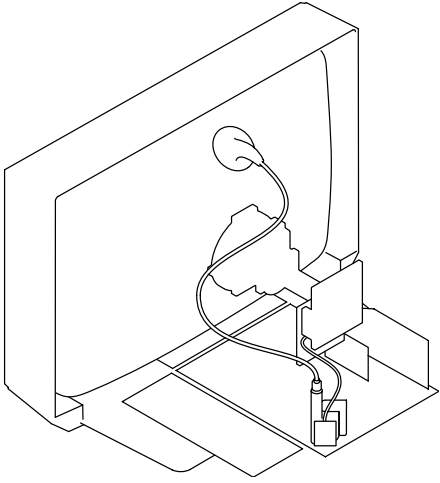

2-5. A BOARD REMOVAL

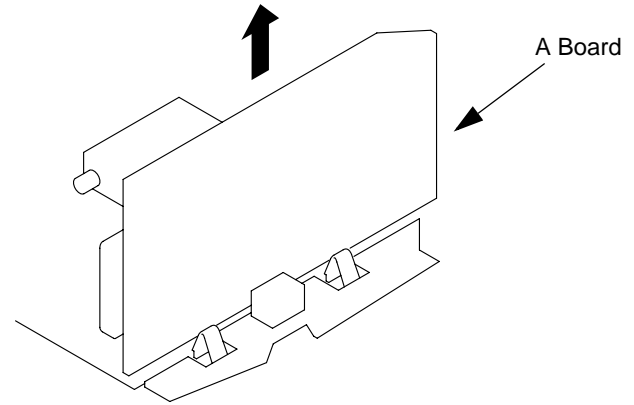

① Remove CN301 before removing A board

2-6. A EXTENSION BOARD

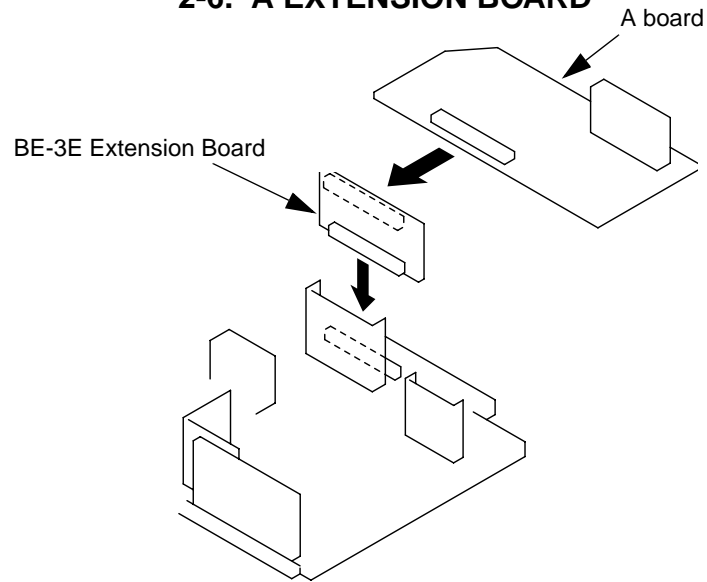

2-7. PICTURE TUBE REMOVAL

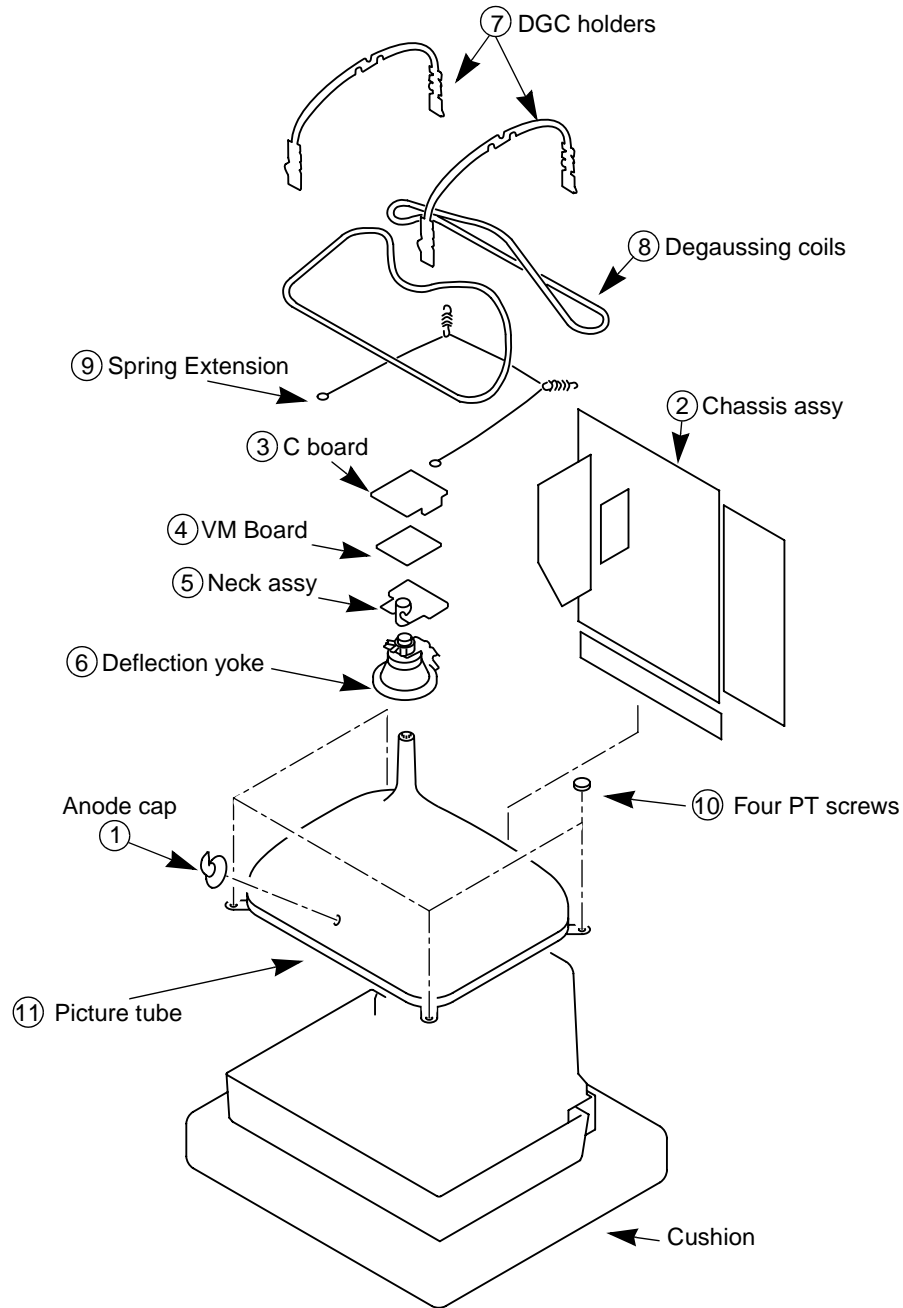

• REMOVAL OF ANODE-CAP

Note : Short circuit the anode of the picture tube and the anode cap to the metal chassis, CRT shield or carbon paint on the CRT, after removing the anode.

* REMOVING PROCEDURES.

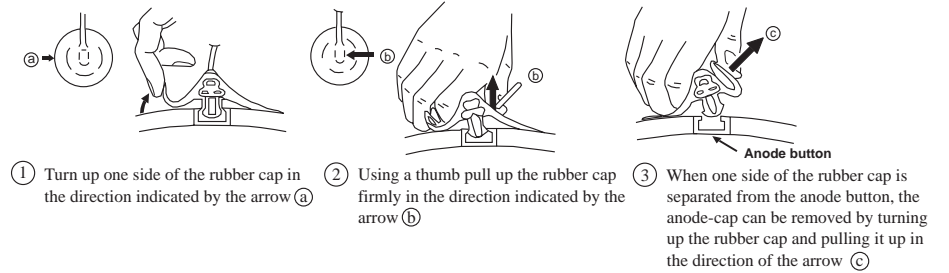

• HOW TO HANDLE THE ANODE-CAP

- ① To prevent damaging the surface of the anode-cap do not use sharp materials.
- ② Do not apply too great a pressure on the rubber, as this may cause damage to the anode connector.
- ③ A metal fitting called a shatter hook terminal is fitted inside the rubber cap. Do not turn the rubber foot over excessively this may cause damage if the shatter hook sticks out.

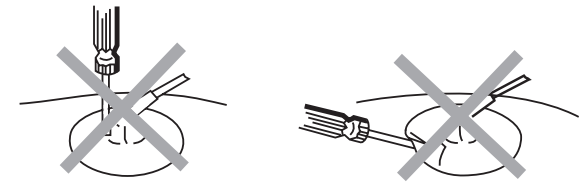

REMOVAL AND REPLACEMENT OF THE MAIN-BRACKET BOTTOM PLATES.

(1) REMOVING THE PLATES

In the event of servicing being required to the solder side of the D Board printed wiring board, the bottom plates fitted to the main chassis bracket require to be removed.

This is performed by cutting the gates with a sharp wire cutter at the locations indicated by arrows.

Note : There are 4 plates fitted to the main bracket and secured by 6 gates.
Only remove the necessary plate to gain access to the printed wiring board.

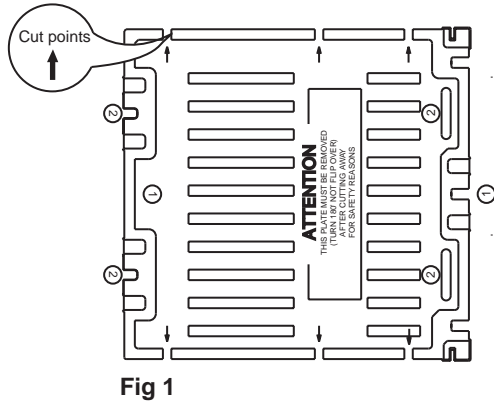

For safety reasons, on no account should the plates be removed and not refitted after servicing.

(2) REFITTING THE PLATES

Because the plates differ in size it is important that the correct plates are refitted in their original location.

The plates are identified by numerical markings on their top side e.g. 1,2

1. Identify the plate by locating its marking.
2. Rotate the plate through 180° (do not flip over).
3. Locate the corresponding numerical markings indicated on the main chassis. See Fig 2.
4. Refit the plate as indicated in Fig 3 with the markings located next to each other.

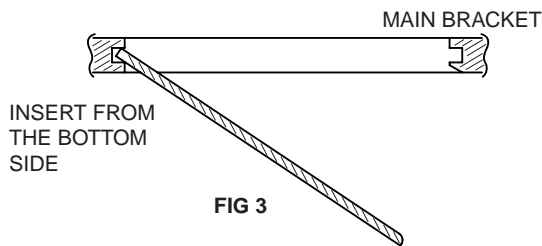
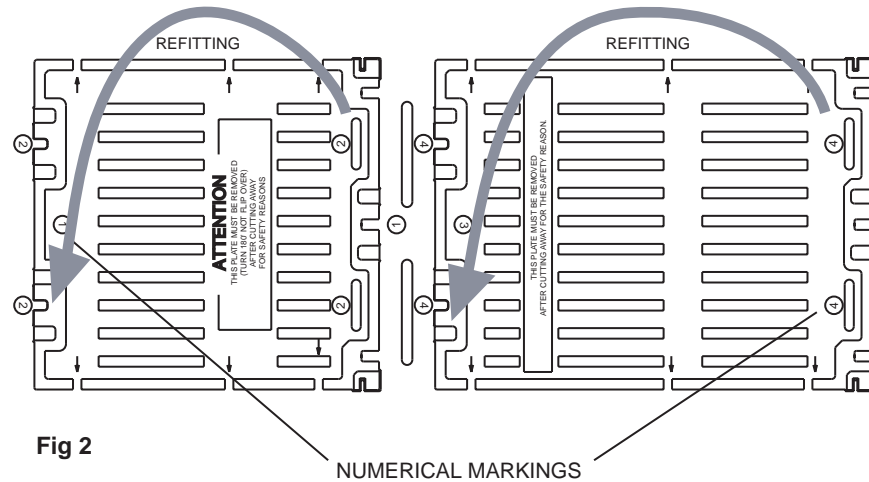

In the event of the plates requiring to be removed at a later stage, this can be achieved by inserting a screwdriver in the snap-recess indicated as in Fig 4 and lifting out.

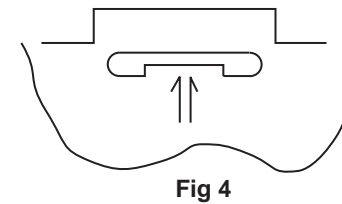

SECTION 3 SET-UP ADJUSTMENTS

- When complete readjustment is necessary or a new picture tube is installed, carry out the following adjustments.
- Unless there are specific instructions to the contrary, carry out these adjustments with the rated power supply.
- Unless there are specific instructions to the contrary, set the controls and switches to the following settings:

Contrast normal
 Brightness normal

Carry out the following adjustments in this order:

- 3-1. Beam Landing
- 3-2. Convergence
- 3-3. Focus
- 3-4. White balance

- Note:** Test equipment required
1. Color bar/pattern generator.
 2. Degausser.
 3. Digital multimeter.
 4. Oscilloscope.

3-1. BEAM LANDING

Preparation:

1. In order to reduce the influence of geomagnetism on the set's picture tube, face it in an easterly or westerly direction.
2. Switch on the set's power and degauss with the degausser.

(1) Adjustment of Correction Magnet for Y-Splitting Axis

1. Input a crosshatch signal from the pattern generator.
2. Set the Picture control to minimum and confirm that the Brightness control is set to normal.
3. Position the neck assembly as indicated in Fig.3-2.
4. Move the deflection yoke as far forward as is possible.
5. Adjust the upper and lower pin symmetrically by opening or closing the Y-splitting axis correction magnets located on the neck assembly.
6. Return the deflection yoke to its original position.

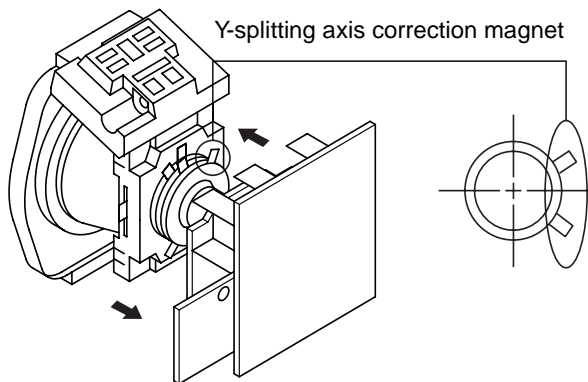

Caution :

High voltages are present on the Deflection yoke terminals - take care when handling the Deflection yoke whilst carrying out adjustments.

(2) Landing

Note : Before carrying out the following adjustments adjust the magnets as indicated below [See Fig.3-3].

1. Input an all-white signal from the pattern generator. Maximize the picture setting and adjust the Brightness setting.
2. Rough-adjust the focus and horizontal convergence.
3. Loosen the deflection yoke screws and align the purity adjustment knob to its central position. [See Fig.3-1].
4. Switch from the all-white pattern to an all-green pattern.
5. Move the deflection yoke backwards and adjust with the purity magnet so that the green is at the centre and it aligns symmetrically. [See Fig.3-4].
6. Move the deflection yoke forward and adjust so that the entire screen becomes green.
7. Switch the raster signal to red, then to blue and verify the landing condition.
8. When the position of the deflection yoke has been determined, fasten the deflection yoke with the screw.
9. If the beam does not land correctly in all the corners of the screen, use magnets to correct it. [See Fig.3-5].

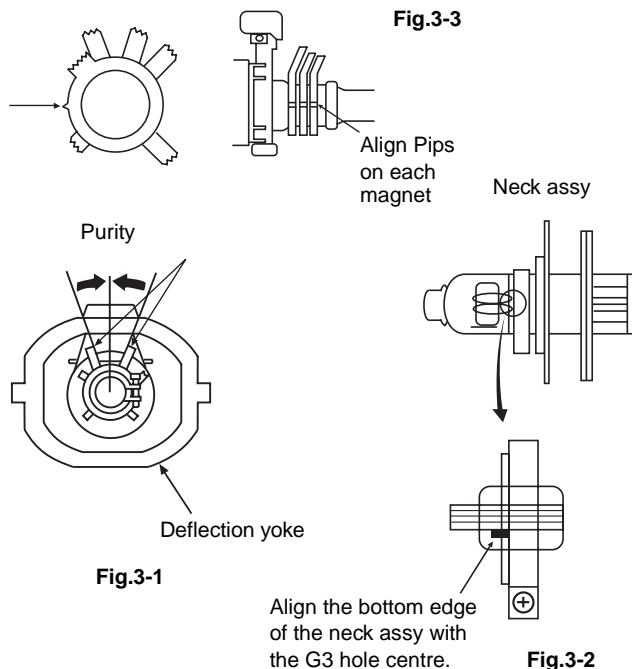

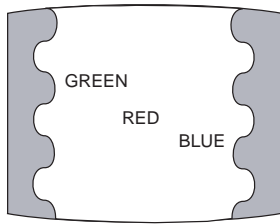

Fig.3-4

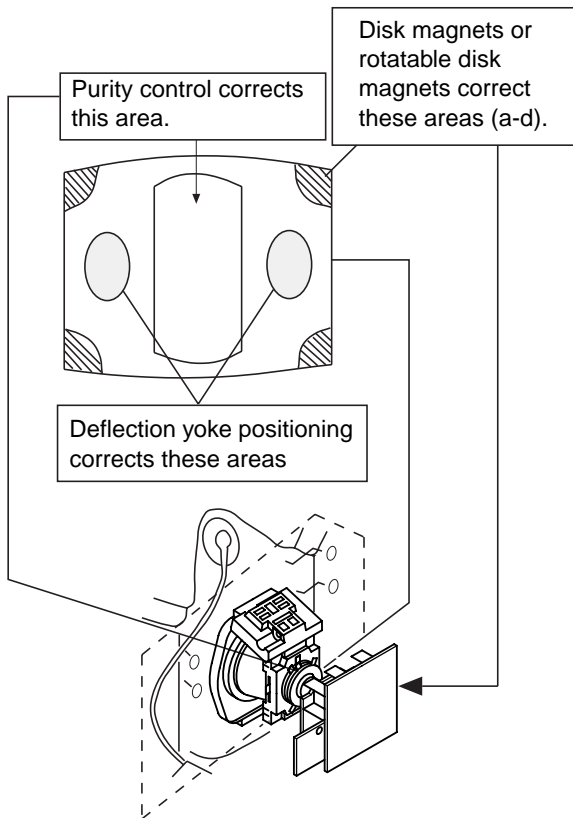
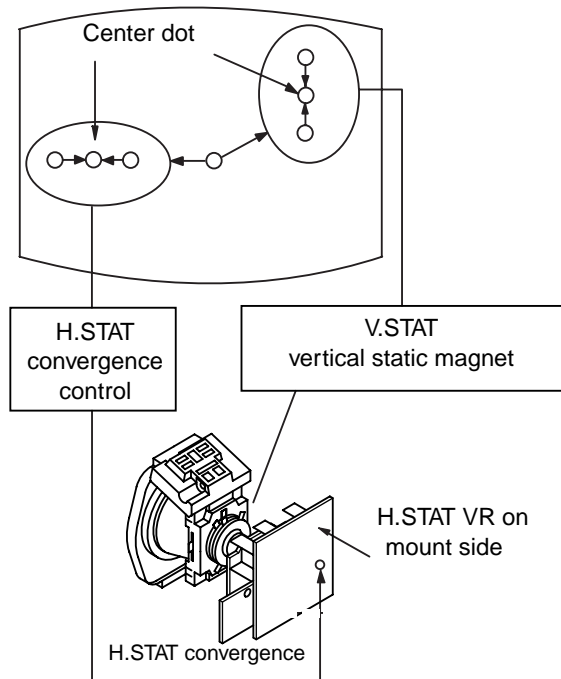

Fig. 3-5

3-2. CONVERGENCE

(1) Screen centre convergence [Static convergence]

1. Input a dot signal from the pattern generator. Normalize the picture setting.
2. [Moving horizontally], adjust the H.STAT control so that the horizontal red, green and blue dots coincide at the centre of the screen.
3. [Moving vertically], adjust the V.STAT magnet so that the vertical red, green and blue dots coincide at the centre of the screen.



- If the horizontal dots are unable to coincide with the variable range of the H.STAT convergence, adjust together with the V.STAT convergence while tracking. [Adjust the convergence by tilting the V.STAT convergence or by opening and closing the V.STAT convergence.]

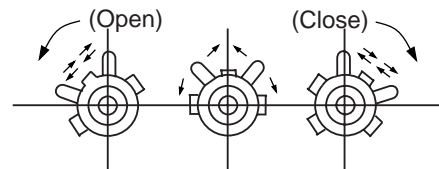

4. Movement of the red, green and blue dots by tilting the V.STAT magnet and by opening or closing the V.STAT magnet.
- a). By opening or closing the V.STAT magnet, the red, green and blue dots move as indicated below.

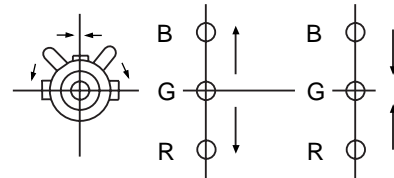

- b). By rotating the V.STAT magnet counter clockwise, the red, green and blue dots move as indicated below.

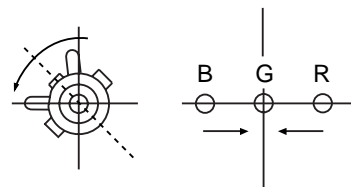

- c). By rotating the V.STAT magnet clockwise, the red, green and blue dots move in the direction indicated below.

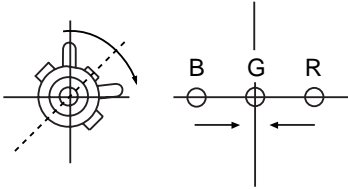

- d). By opening or closing the V.STAT magnet, the red, green and blue dots move in the direction indicated below.

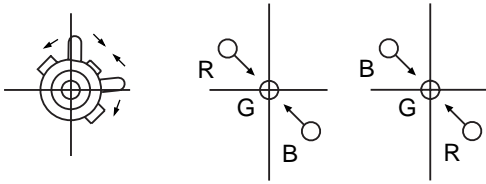

Note : If the blue dot does not coincide with the red and green points correct the points by using the BMC [Hexapole] magnet.

5. Correction for HMC [horizontal mis-convergence] and VMC [vertical mis-convergence] by using the BMC [Hexapole] magnet.

- a). HMC correction by BMC [Hexapole] magnet and movement of the electron beam.

HMC correction(A)

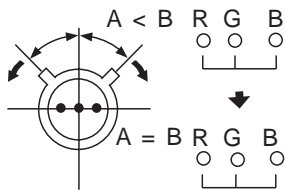

HMC correction(B)

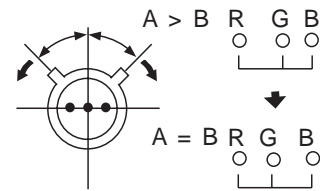

- b). VMC correction by BMC [Hexapole] magnet and movement of the electron beam.

VMC correction(A)

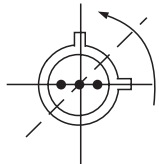

VMC correction(B)

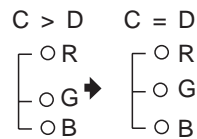
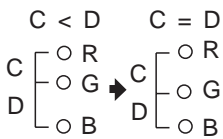
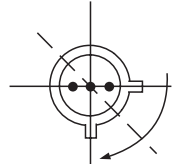

HAMP

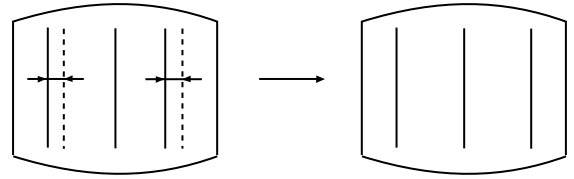

6. HTIL correction can be performed by adding a THL correction ASSY to the DY.

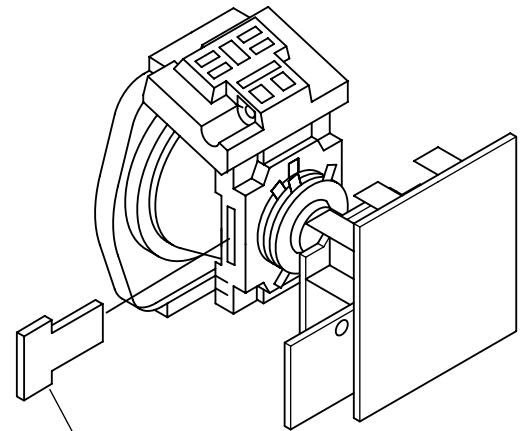

TLH correction Assy
4-057-714-01

HTIL

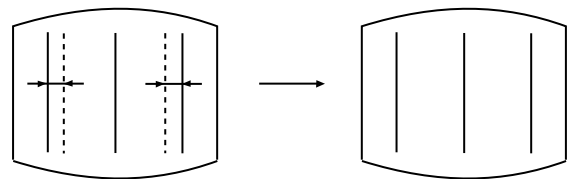

LAYOUT OF EACH CONTROL

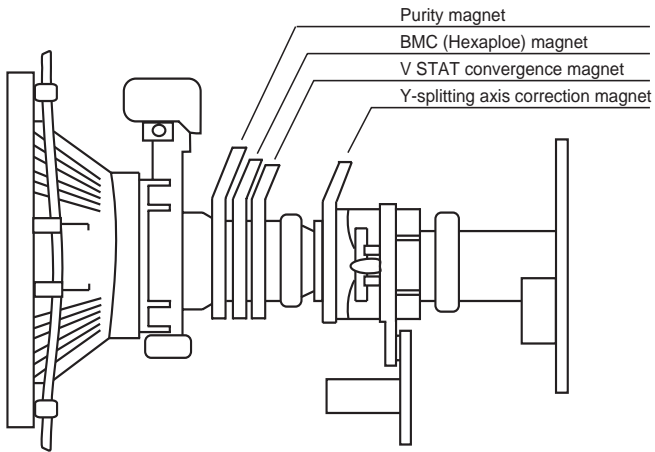
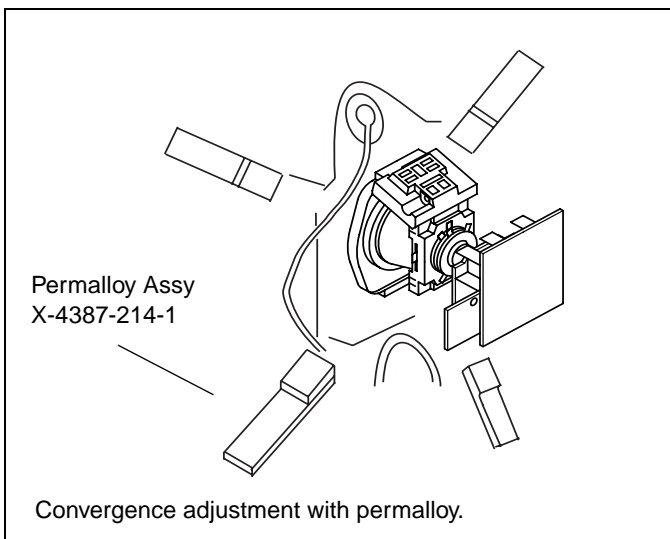
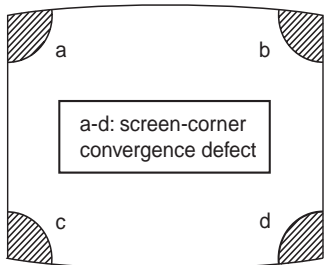

Fig 3-6

Note : If you are unable to adjust the corner convergence properly, this can be corrected with the use of permalloys.



3-3. SCREEN (G2)

SCREEN G2 ADJUSTMENT

1. Input a dot signal from the pattern generator.
2. Set the Picture, Brightness and Colour to minimum.
3. Apply 175V DC from an external power supply to the R, G and B cathodes of the CRT.
4. Whilst watching the picture, adjust [SCREEN G2] located on the FBT [flyback transformer] to the point just before the flyback return lines disappear.

3-4. FOCUS

1. Receive a television broadcast signal.
2. Normalise the picture setting.
3. Adjust the focus control located on the FBT [flyback transformer] to obtain the best focus at the centre of the screen. Bring only the centre area of the screen into focus, the magenta-ring appears on the screen. In this case, adjust the focus to optimize the screen uniformly.

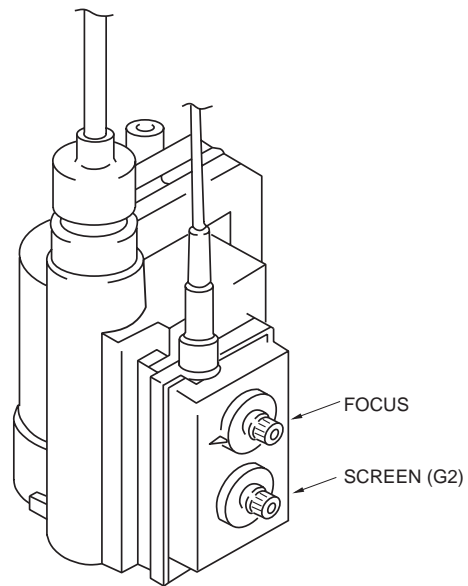

3-5. WHITE BALANCE

WHITE BALANCE ADJUSTMENT

1. Input an all white signal from the pattern generator.
2. Enter into the Service Mode.
3. Enter into the 'Picture Adjustment' service menu.
4. Select 'Sub contrast' and adjust to 7.
5. Select the 'Green drive' and adjust so that the white balance becomes optimum.
6. Select the 'Blue drive' and adjust so that the white balance becomes optimum.
7. Press the 'TV' button on the remote commander to return to TV operation.

PICTURE ADJUSTMENT	
AFC mode	1
REF position	2
SCP BGR	1
SCP BGF	1
Trap fo	0
Sub contrast	Adj
Sub colour	Adj
Sub brightness	Adj
Sub hue	Adj
Green drive	Adj
Blue drive	Adj
Green cutoff	Adj
Blue cutoff	Adj
Gamma	0
Pre / overshoot	3
Y delay	3

SECTION 4 CIRCUIT ADJUSTMENTS

4-1. ELECTRICAL ADJUSTMENTS

Service adjustments to this model can be performed using the supplied Remote Commander RM-887.

HOW TO ENTER INTO SERVICE MODE

1. Turn on the main power switch and enter into the stand-by mode.
2. Press the following sequence of buttons on the Remote Commander.

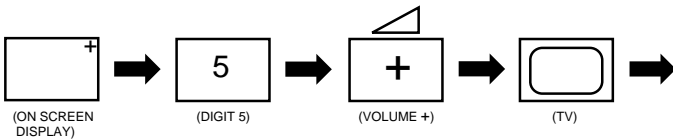

- 'TT--' will appear in the upper right corner of the screen. Other status information will also be displayed.
3. Press 'MENU' on the remote commander to obtain the following menu on the screen.

TEST MENU	
>	Picture Adjustment
	Geometry
	Wide
	IC status
	MSP
	Dynamic Convergence
	Current TV status

4. Move to the corresponding adjustment using the button on the remote commander.
5. Press the + button to enter the selected adjustment.
6. Turn off the power to quit the service mode when adjustments have been completed.

PICTURE ADJUSTMENT	
AFC mode	1
REF position	3
SCP BGR	1
SCP BGF	1
Trap fo	9
Sub contrast	Adj
Sub colour	Adj
Sub brightness	Adj
Green drive	Adj
Blue drive	Adj
Green cutoff	Adj
Blue cutoff	Adj
Gamma	0
Pre / overshoot	0
Y delay	3
D Pic	ON/OFF
D Colour	ON/OFF
DC Transfer	ON/OFF

GEOMETRY ADJUSTMENT - 4:3	
V size	Adj
V position	Adj
S Correction	Adj
V Linearity	Adj
H size	Adj
H position	Adj
Pin Amp	Adj
Pin Phase	Adj
AFC Bow	Adj
AFC Angle	Adj
EHT V	1
EHT H	0
Lo Corn Pin	Adj
Up Corn Pin	Adj

WIDE ADJUSTMENT - 4:3	
V Aspect	0
V Scroll	25
Upper V Lin	0
Lower V Lin	0
Left Blanking	1
Right Blanking	11

MSP

AGC ON/OFF	ON
Constant gain CDB	0
FM prescale FMP	36
Zwei mono-st WHI	36
Zwei st-mono WLO	18
Zwei mono-bi WMH	36
Zwei bi-mono WLO	18
Time Zwei WML	41
Fawct limit	10
Fawct soll init FAW	12
Fawer tol	2
Nicam Err Max CCT	10
Nicam Err Min	0
Nicam Prescale NIP	97
Time Nicam	31
Carrier mute CRM	OFF
Audio clock ACO	HIZ
Scart prescale	25
Scart volume	64

IC STATUS (CXA2076 / CXA2040)

CXA2076	
H lock	1
IKR	1
VNG	0
X-RAY	0
Colour system	3
CV1 sync	1
CXA2040	
Sync sep	1
S1 mode pin	01
S2 mode pin	01
TUNER	
Tuner status	01101011

TV STATUS BE3E

Text system	C TEXT/C TEXT 2
Dolby	NO-FX,DX / YES-DS
DSP Present	NO-FX,DX / YES-DS
Text language set	WEST/EAST/RUSSIAN
Menu language set	WEST/EAST/RUSSIAN
Destination	B/D/U/K/L/E/A/R
Ageing	OFF/ON
Auto Shut Off	OFF/ON
Size	28/32
Colour trap sw	SECAM/ALL
Velocity mod	ON/OFF
AFT STATUS	WINDOW/HIGH/LOW
Digital RF	ON/OFF
Attenuation	ON/OFF
Micro/Jungle	SDA30C263/CXA2076

Dynamic Convergence

Range	Adj Off - 42
H stat	Adj Off - 63
H amp l	Adj Off - 63
H amp r	Adj Off - 63
Up Y	Adj Off - 63
Low Y	Adj Off - 63
Y up l	Adj Off - 63
Y up r	Adj Off - 63
Y low l	Adj Off - 63
Y low r	Adj Off - 63
Mbow up l	Adj Off - 63
Mbow up r	Adj Off - 63
Mbow low l	Adj Off - 63
Mbow low r	Adj Off - 63
V Stat	Adj Off - 63

SUB BRIGHTNESS ADJUSTMENT

1. Input a Phillips pattern.
2. Set the picture control to minimum.
3. Enter into the 'Picture Adjustment' service menu.
4. Adjust the 'Sub-Brightness' data so that there is barely a difference between the 0 IRE and 10 IRE signal levels.

SUB CONTRAST ADJUSTMENT

1. Input a video that contains a small 100% area on a black background.
2. Set the picture control to maximum.
3. Connect an oscilloscope to Pin 3 of CN301 [A Board].
4. Enter into the 'Picture Adjustment' service menu.
5. Adjust the 'Sub-contrast' data to obtain a black to white amplitude of 2.20V.

SUB COLOUR ADJUSTMENT

1. Receive a PAL colour bar video signal.
2. Connect an oscilloscope to Pin 3 of CN301 [A Board].
3. Enter into the 'Picture Adjustment' service menu.
4. Adjust the 'Sub-colour' data so that the Cyan, Magenta and Blue colour bars are of equal height

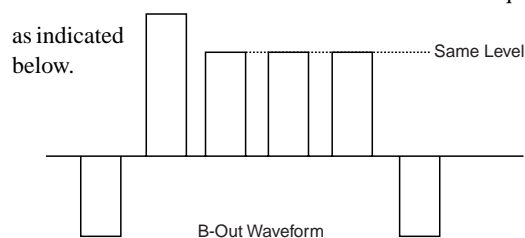

Note: The data indicated in the 'TV STATUS' table is dependant on destination, screen size and country.

SYSTEM B/G, D/K, I & L I.F ADJUSTMENT

1. Input an off air signal of between 60-100dBuV / 75 ohm terminated, via the tuner socket.
2. Enter into the 'IF Adjustment' service mode [i.e 'TT59'] to fix the I.F frequency to 39.9MHz.
3. Enter into the service mode and select 'Current TV status'.
4. Adjust the I.F coil [LV01] until the 'AFT Status' indicates a 'Window' condition.

SYSTEM L BAND 1 I.F ADJUSTMENT

1. Input an off air signal of between 60-100dBuV / 75 ohm terminated, via the tuner socket.
2. Enter into the 'IF Adjustment' service mode [i.e 'TT59'] to fix the I.F frequency to 34.2MHz.
3. Enter into the service mode and select 'Current TV status'.
4. Adjust the RV02 control until the 'AFT Status' indicates a 'Window' condition.

TUNER AGC ADJUSTMENT

1. Receive a signal of 63dBuV / 75 ohm terminated, via the tuner socket.
2. Measure the voltage at test point 1 [A Board].
3. Adjust RV01 control to obtain a voltage of 3.0V +/- 0.3V.

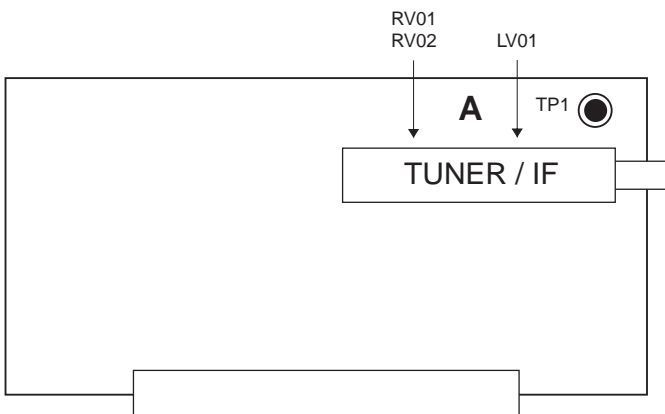

DEFLECTION SYSTEM ADJUSTMENT

1. Enter into the 'Geometry Adjustment' service menu.
2. Select and adjust each item in order to obtain the optimum image.

GEOMETRY ADJUSTMENT	
V size	Adj
V position	Adj
S Correction	Adj
V Linearity	Adj
H size	Adj
H position	Adj
Pin Amp	Adj
Pin Phase	Adj
AFC Bow	Adj
AFC Angle	Adj
EHT V	1
EHT H	0
Lo Corn Pin	Adj
Up Corn Pin	Adj

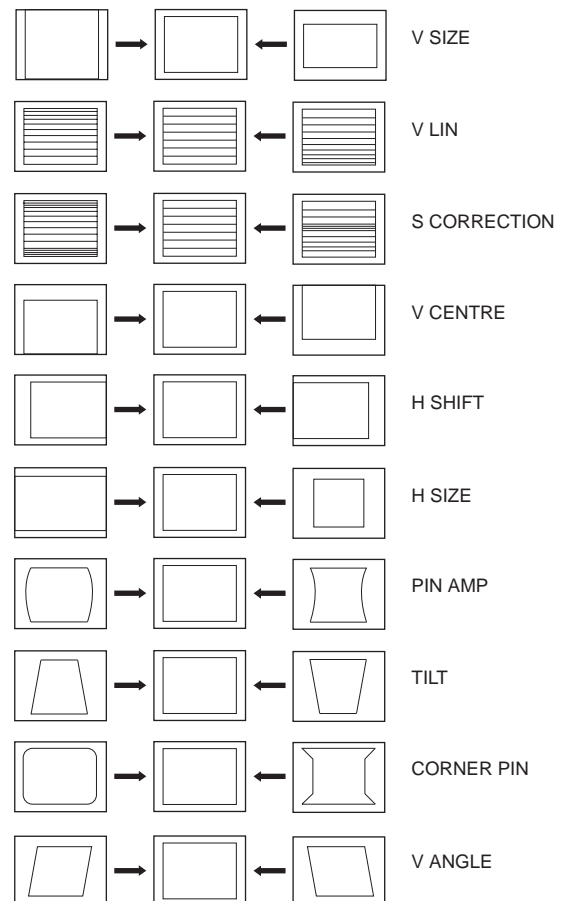

4-2. 'TT' TEST MODE :

'TT' Mode is available by pressing the Test key twice. It is exited by pressing 0 twice, or by pressing the Test key, or by pressing the TV key, or by pressing the TV key, or by switching the set into standby.

The functions described below are available by pressing 2 digits:

00	Cancel Test mode
01	Picture Maximum
02	Picture Minimum
03	Volume & Headphone Volume 35%
04	Volume & Headphone Volume 50%
05	Volume & Headphone Volume 65%
06	Volume & Headphone Volume 80%
07	Ageing mode Enable/Disable
08	Shipping Condition
09	Display TV status
10	No function
11	Sub Picture adjustment
12	Sub Colour adjustment
13	Sub Brightness adjustment
14	Text H-Position adjustment
15	Rotation Test
16	No function
17	No function
18	No function
19	No function
20	No function
21	Destination A/D (East Menu/West Text)
22	Destination L (West Menu/West Text)
23	Destination E (West Menu/West Text)
24	Destination U (West Menu/ West Text)
25	Destination D (East Menu/Greek Text)
26	Destination B (East Menu/West Text)
27	Destination K (East Menu/East Text)
28	Destination R (Russian Menu/Russian Text)
29	No function
30	No function
31	Toggle Auto Shutoff Disable
32	Toggle Bit Error Rate Display
33	Toggle Terminal Debug Mode
34	No function
35	No function
36	No function
37	No function
38	Default Dynamic Convergence Settings
39	No function
40	No function
41	Re-initialize the NVM

42	Re-initialise geometry settings
43	Default Programme info in NVM with factory settings
44	Default favourite pages to 100,101,102 and 103
45	Switch off all Parental locks
46	No function
47	Default MSP settings
48	Set NVM as Non-virgin
49	Set NVM as virgin
50	No function
51	Dolby Pro-Logic On, Volume 90%
52	Noise On Left Speaker
53	Noise On Right Speaker Only
54	Noise On Centre Speaker Only
55	Noise On Surround Speaker Only
56	Set Colour to Minimum and Picture to Maximum
57	Set Colour and Picture to Minimum and Adjust Sub-Brightness
58	No function
-	No function
60	No function
61	N-board Reset
62	Toggle the 3.3v regulator on A2-board
63	Toggle Attenuation switch on Port Expander
64	Smart Link Test- Toggle the Smart Link pin 50 times
65	No function
66	No function
67	No function
68	Pre-set AV Labels
69	No function
70	No function
71	Select Compact Text/Compact Text-2
72	Balance Left/Right (press ← key for balance left, → for balance right, and ↑ for centre balance)
73	Dual Sound Headphones (↑key for A, ↓ key for B)
74	Dual Sound Speakers (↑key for A, ↓ key for B)
75	DSP Bypass
76	Dolby Enabled/Disabled toggle
77	Setup trap switch
78	Set Screen Size
79	Wide Setup
80	No function
81	Velocity Mod ON
82	Velocity Mod OFF

83	Special Picture Mode - Personal mode, reset & brightness = 0
84	Text Interlace odd (Non interlace mode = 3)
85	Text Interlace even (Non interlace mode = 2)
86	Auto Cut Off ENABLE
87	Auto Cut Off DISABLE
88	Diagnostics OFF
89	Diagnostics ON
90	No function
91	Clear & disable OSD
92	Enable OSD
93	D/K Nicam Enable
94	D/K Nicam Disable
95	Reset language select menu on power up
96	Set all programme labels to default
97	Toggle MHEG Mode

4-3. 'T' TEST MODE :

'T' Mode is available by pressing the Test key once. It is exited by pressing the Test key twice, or by pressing the TV key, or by switching the set into standby.

The functions described below are available by pressing the indicated key :

Key	T Mode Function
Volume +	Volume Maximum
Volume -	Volume Minimum
Picture +	Picture Maximum
Picture -	Picture Minimum
Colour +	Colour Maximum
Colour -	Colour Minimum
Brightness +	Brightness Maximum
Brightness -	Brightness Minimum
Hue +	Hue Maximum
Hue -	Hue Minimum
Sharpness +	Sharpness Maximum
Sharpness -	Sharpness Minimum
Balance Left	Balance Full Left
Balance Right	Balance Full Right
Treble +	Treble Maximum
Treble -	Treble Minimum
Bass +	Bass Maximum
Bass -	Bass Minimum
Analogue +	Select Analogue Value Maximum
Analogue -	Select Analogue Value Minimum

5-1 BLOCK DIAGRAMS (1)

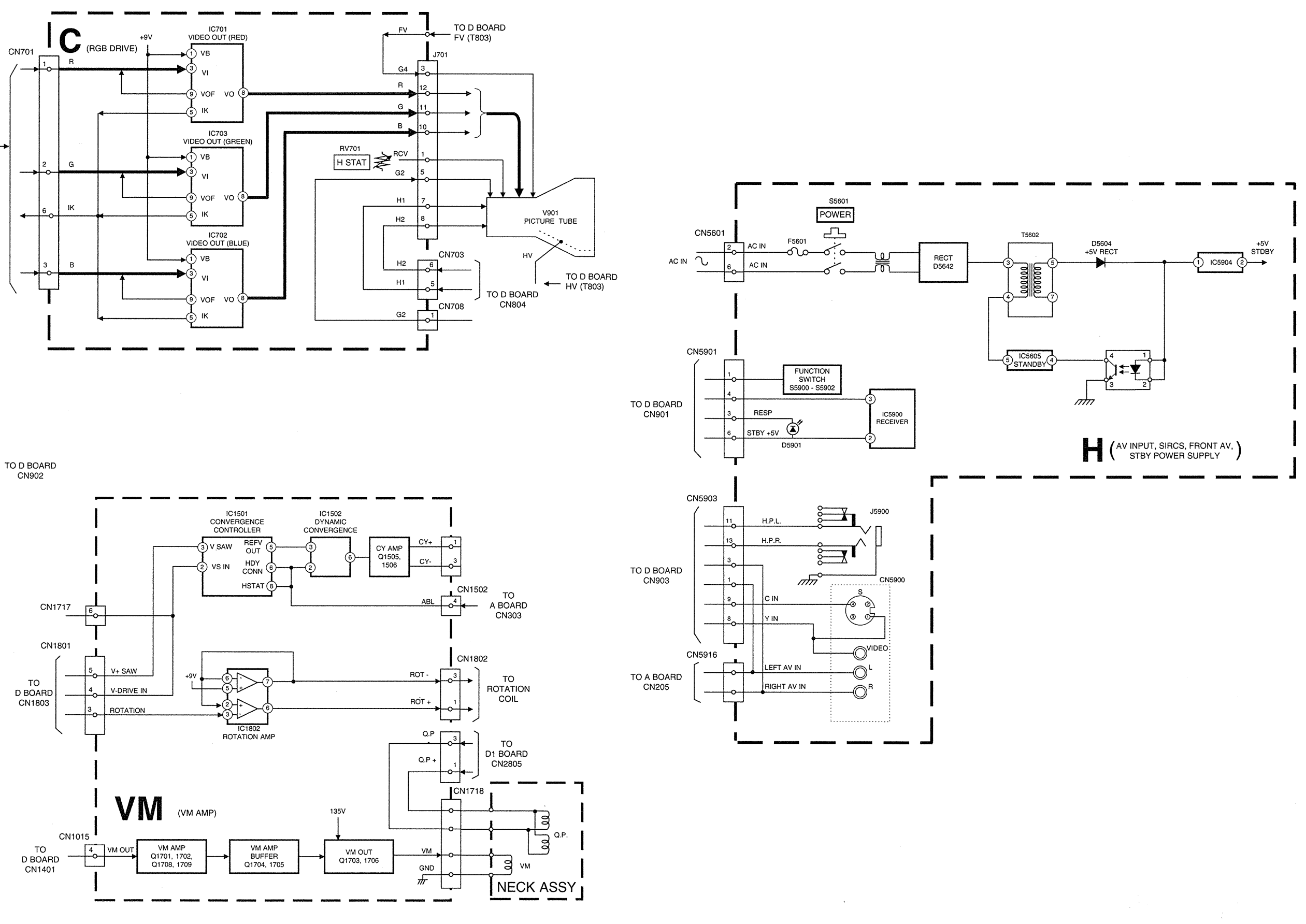
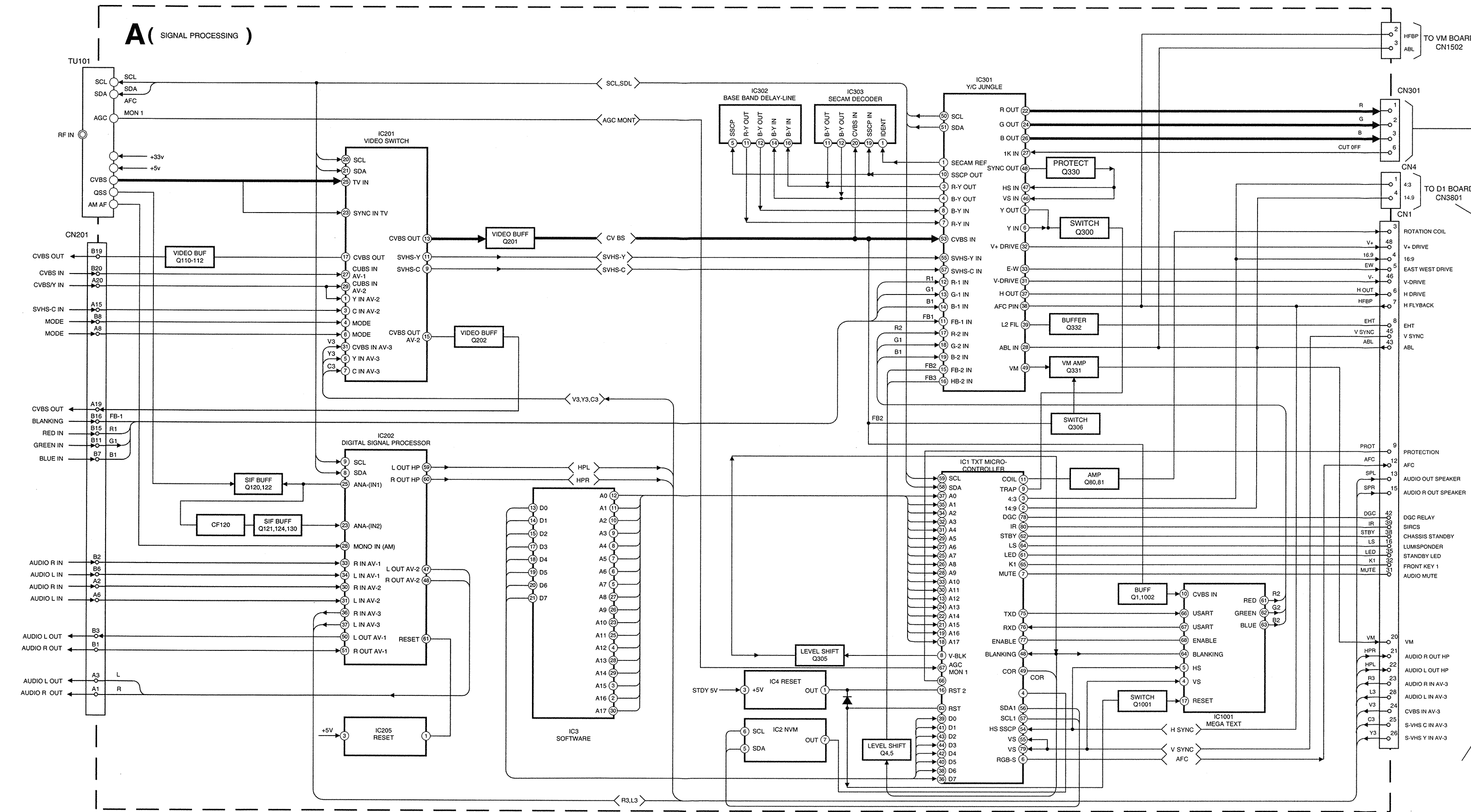

5-1 BLOCK DIAGRAMS (2)

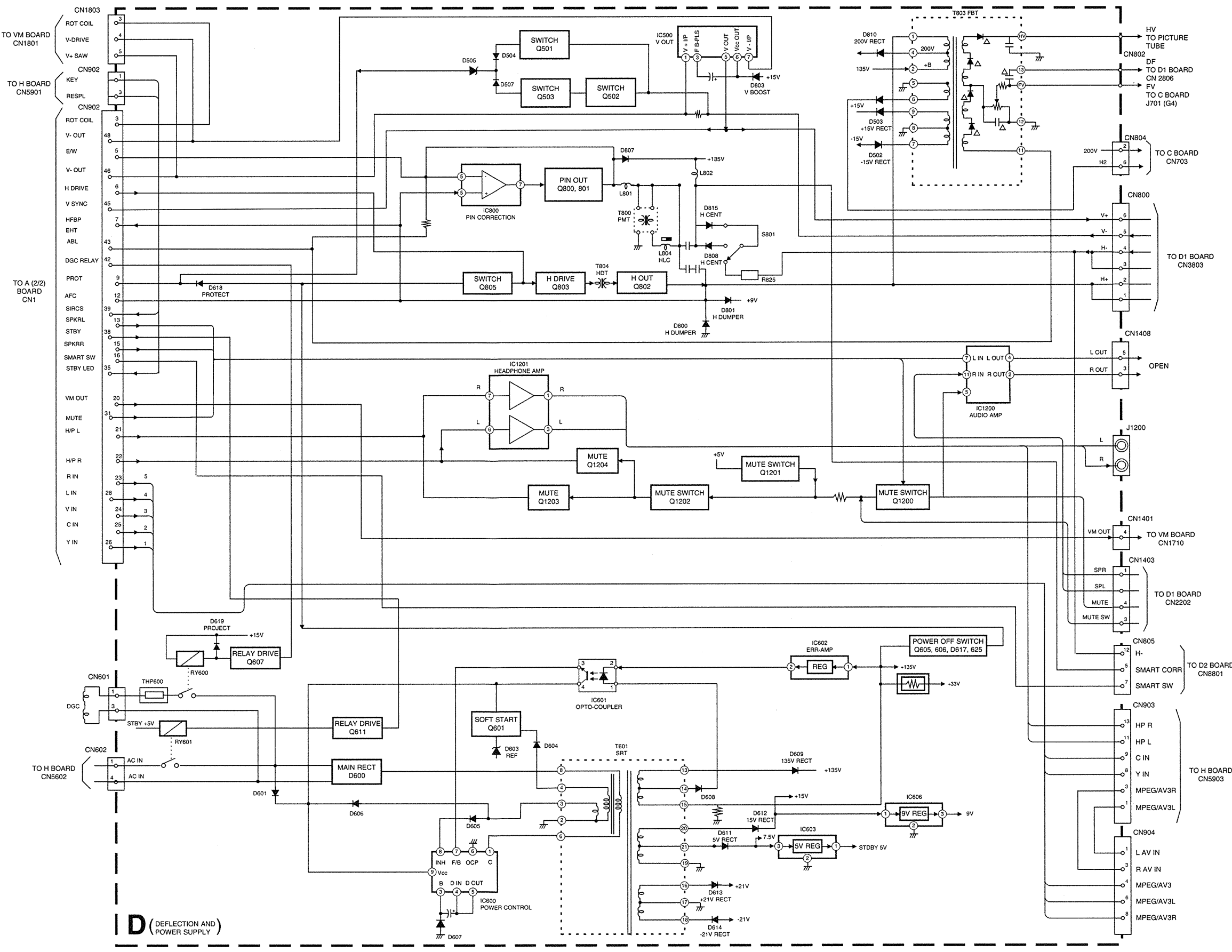
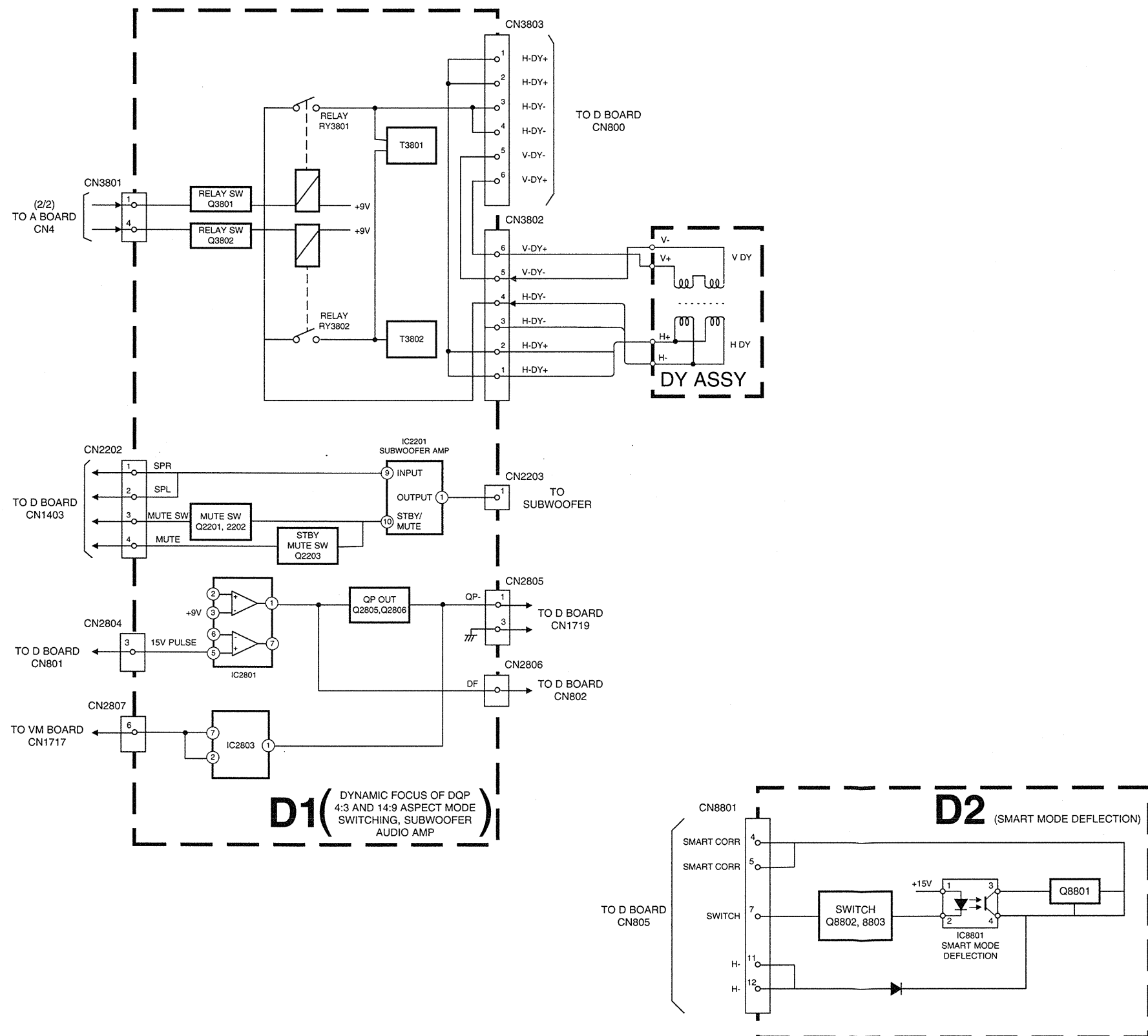

5-2. CIRCUIT BOARD LOCATION

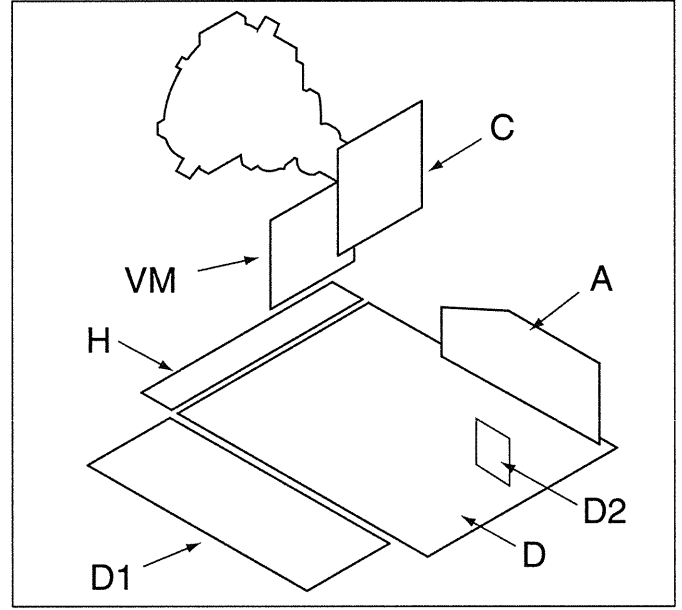

5-3. SCHEMATIC DIAGRAMS AND PRINTED WIRING BOARDS

- Note :**
- All capacitors are in μF unless otherwise noted.
 - pF : μF 50WV or less are not indicated except for electrolytic types.
 - Indication of resistance, which does not have one for rating electrical power, is as follows.
- Pitch : 5mm
Electrical power rating : 1/4W
- Chip resistors are 1/10W
 - All resistors are in ohms.
 - $k = 1000$ ohms, $M = 1000,000$ ohms
- : nonflammable resistor.
 - : fusible resistor.
 - : internal component.
 - : panel designation or adjustment for repair.
- All variable and adjustable resistors have characteristic curve B, unless otherwise noted.
 - All voltages are in Volts.
 - Readings are taken with a 10Mohm digital multimeter.
 - Readings are taken with a color bar input signal.
 - Voltage variations may be noted due to normal production tolerances.
- : B + bus.
 - : B - bus.
 - : RF signal path.
 - : earth - ground.
 - : earth - chassis.

Reference Information

RESISTOR	RN	: METAL FILM
	RC	: SOLID
	FPRD	: NON FLAMMABLE CARBON
	FUSE	: NON FLAMMABLE FUSIBLE
	RS	: NON FLAMMABLE METAL OXIDE
	RB	: NON FLAMMABLE CEMENT
	RW	: NON FLAMMABLE WIREWOUND
		: ADJUSTMENT RESISTOR
COIL	LF-8L	: MICRO INDUCTOR
CAPACITOR	TA	: TANTALUM
	PS	: STYROL
	PP	: POLYPROPYLENE
	PT	: MYLAR
	MPS	: METALIZED POLYESTER
	MPP	: METALIZED POLYPROPYLENE
	ALB	: BIPOLAR
	ALT	: HIGH TEMPERATURE
	ALR	: HIGH RIPPLE

Note : The components identified by shading and marked Δ are critical for safety. Replace only with the part numbers specified in the parts list.

Note : Les composants identifiés par une trame et par une marque Δ sont d'importance critique pour la sécurité. Ne les remplacer que par des pièces de numéro spécifié.

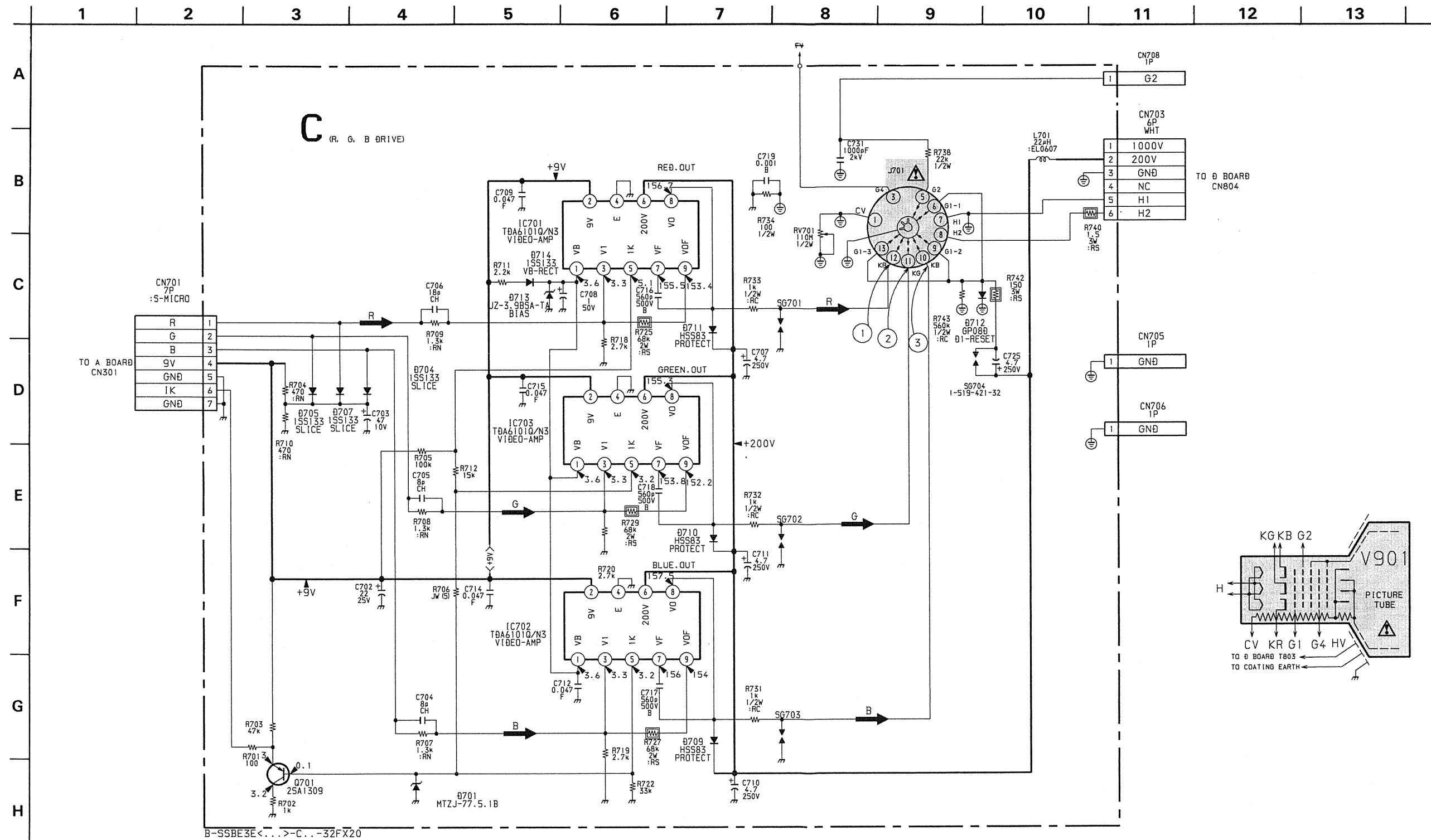

C [R, G, B DRIVE]

C Board

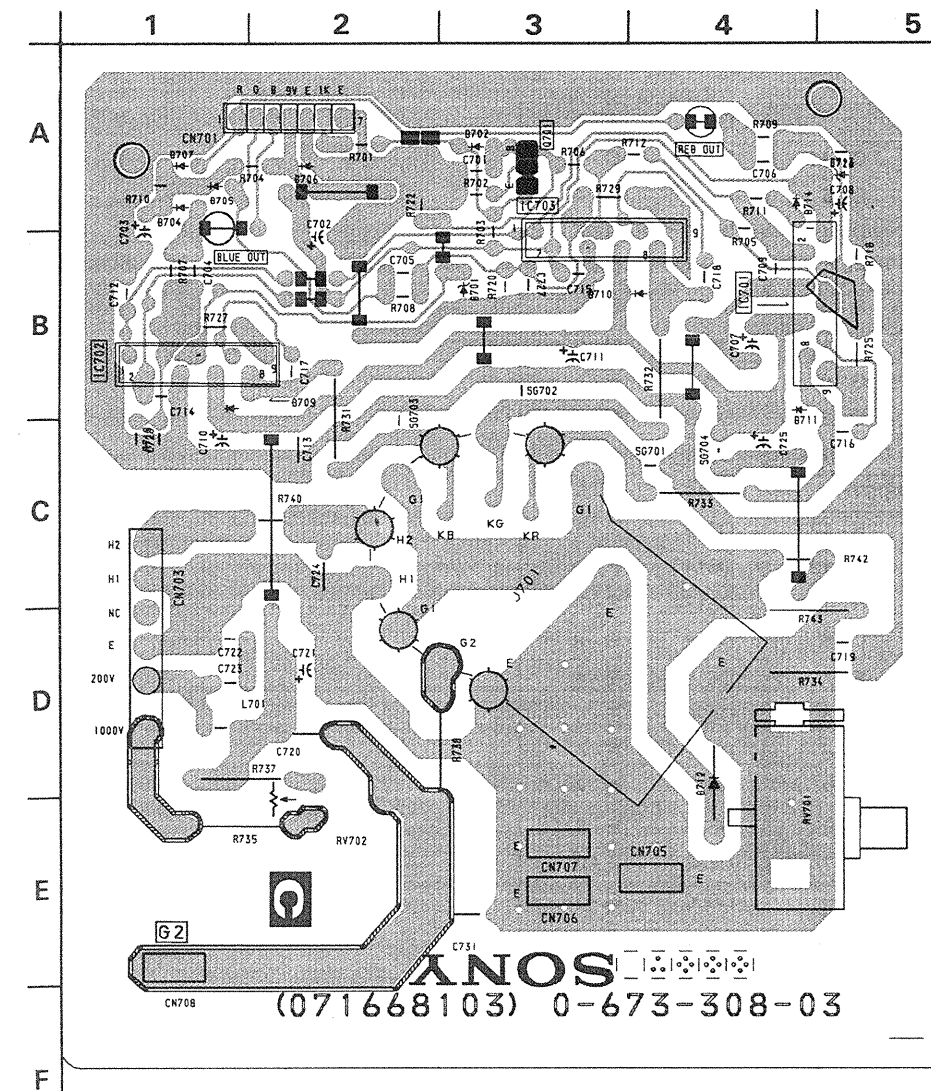

C BOARD

IC	
IC701	B - 4
IC702	B - 1
IC703	A - 3
TRANSISTOR	
Q701	A - 3
DIODE	
D701	B - 3
D704	A - 1
D705	A - 1
D707	A - 1
D709	B - 1
D710	B - 3
D711	B - 4
D712	D - 4
D713	A - 4
D714	A - 4

WAVEFORMS C BOARD

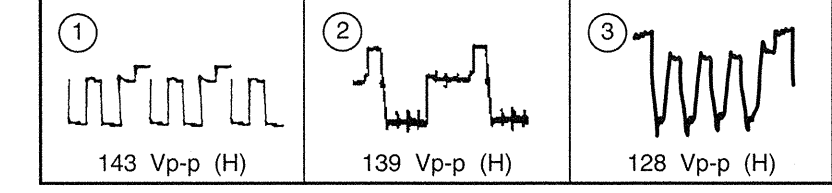

A
B
C
D
E
F
G
H
I
J
K
L
M
N

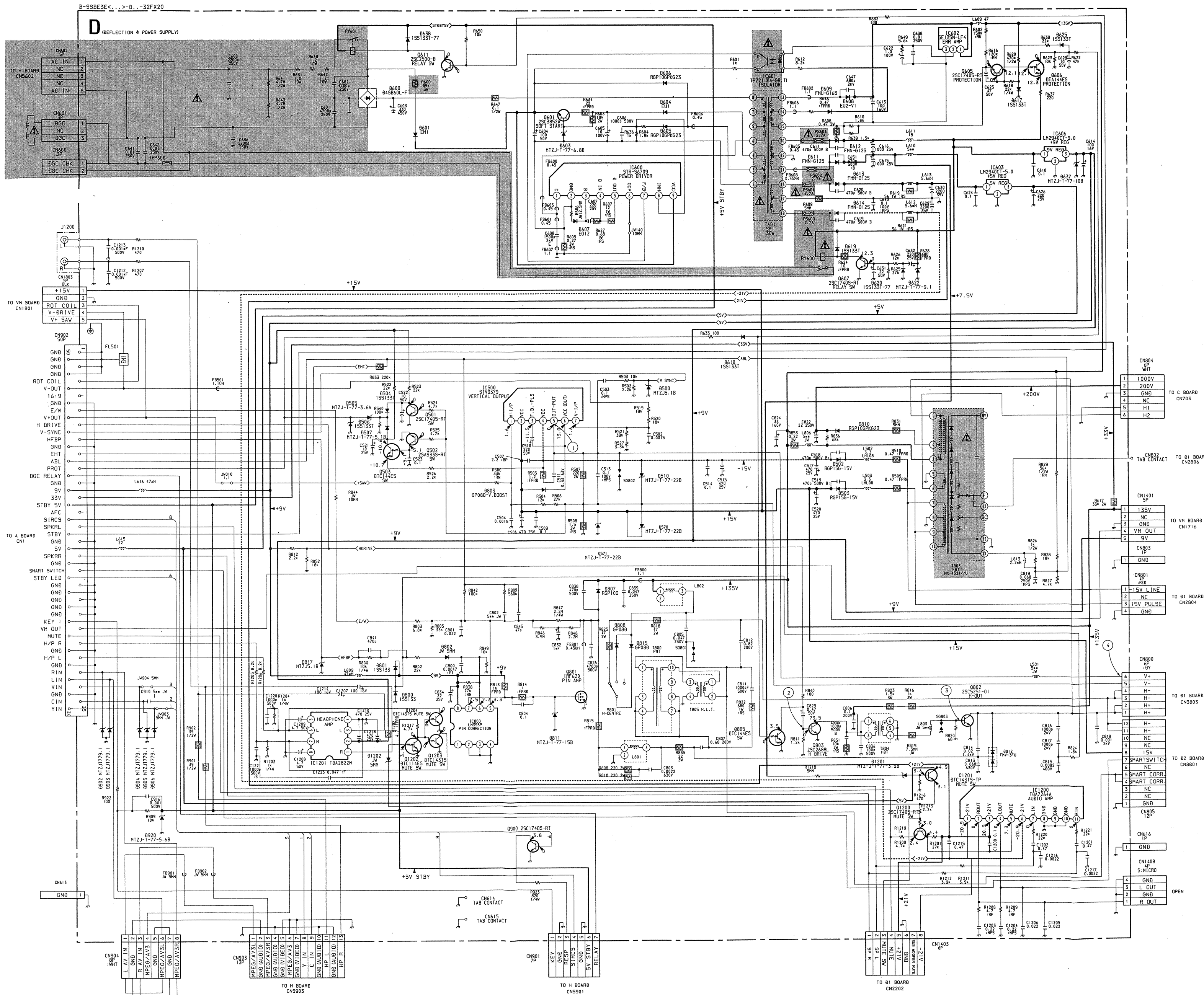

WAVEFORMS D BOARD

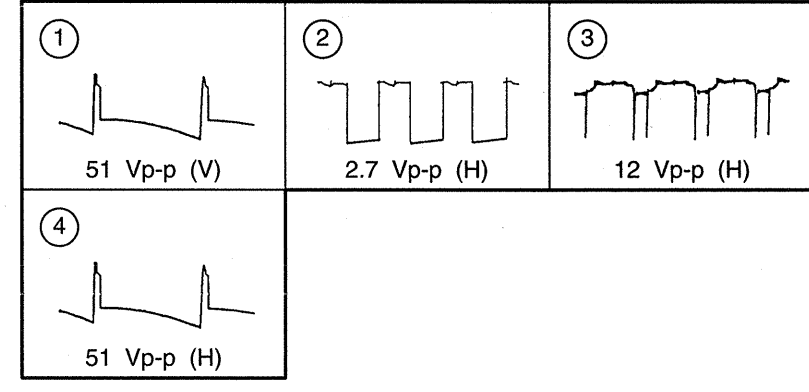

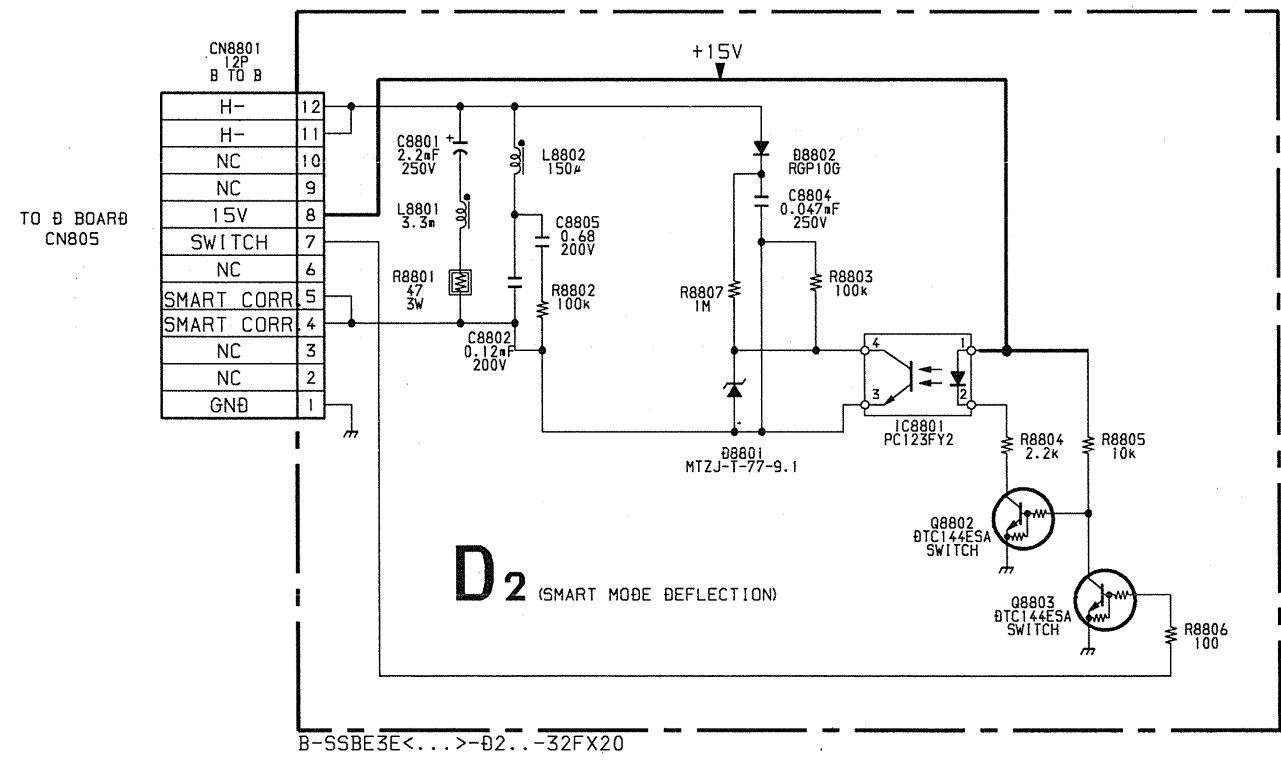

D2 SMART MODE DEFLECTION

D2 Board

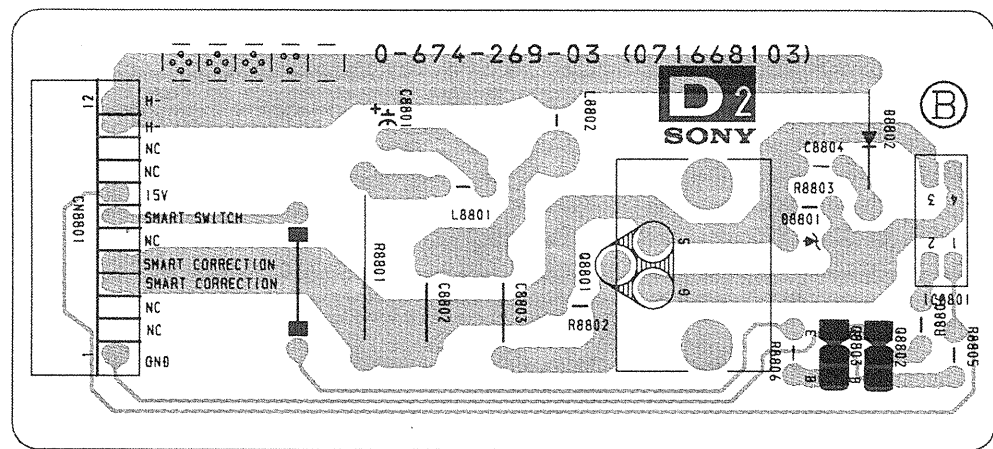

VM VELOCITY MODULATION & DYNAMIC CONVERGENCE

VM Board

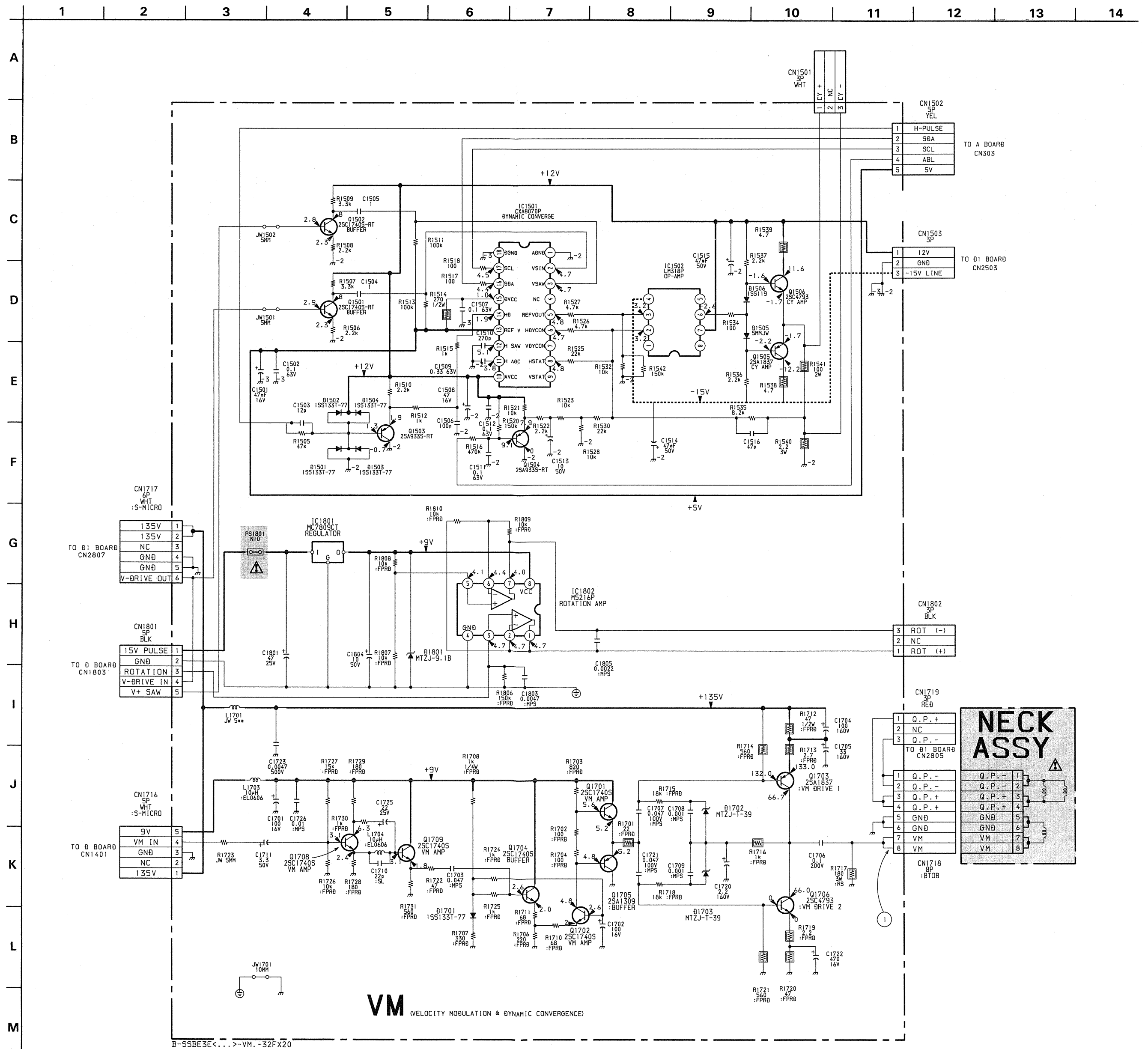
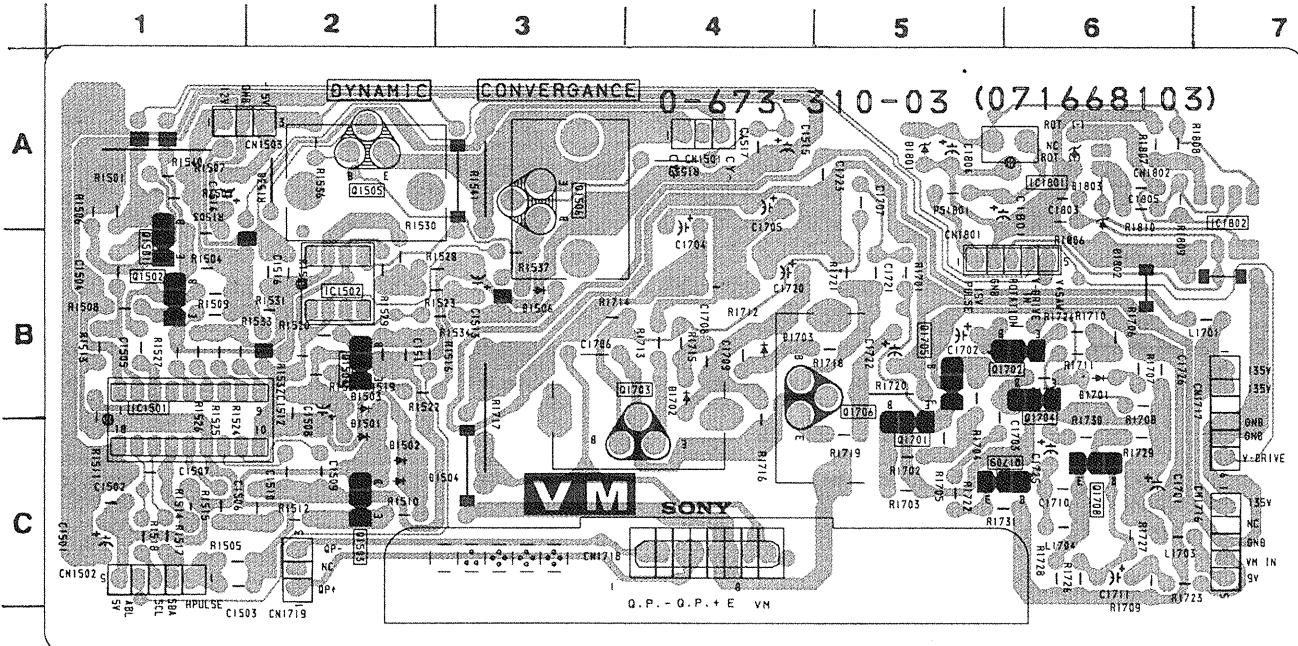

H AV INPUT, SIRCS, FRONT AV STBY POWER SUPPLY

H Board

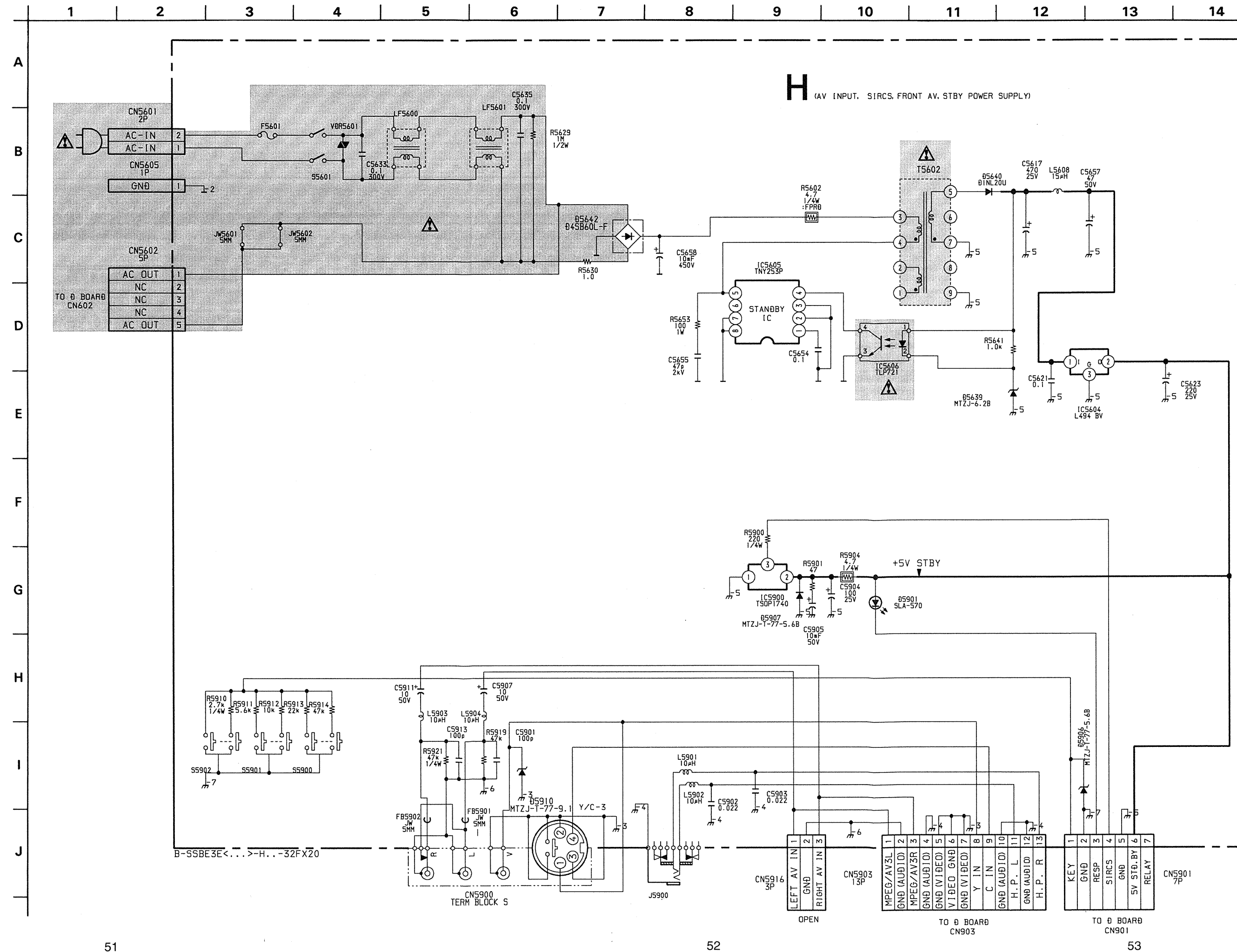
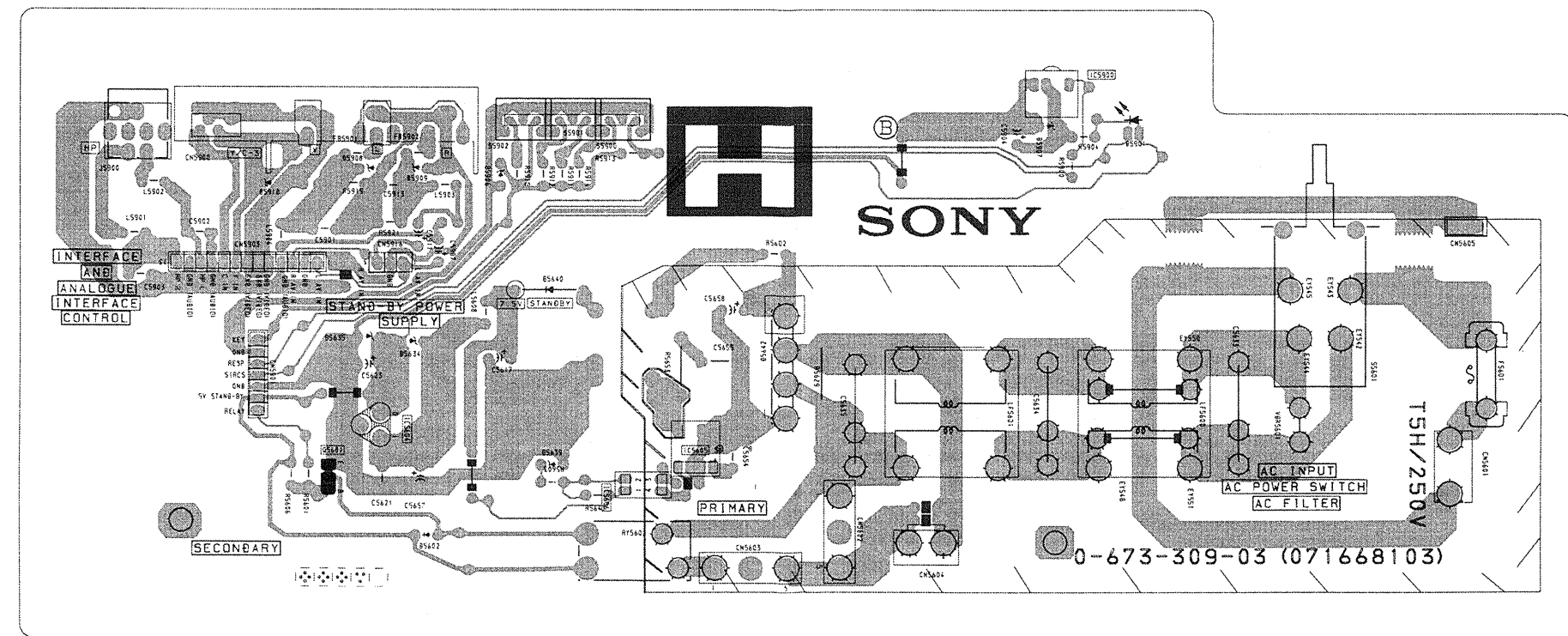

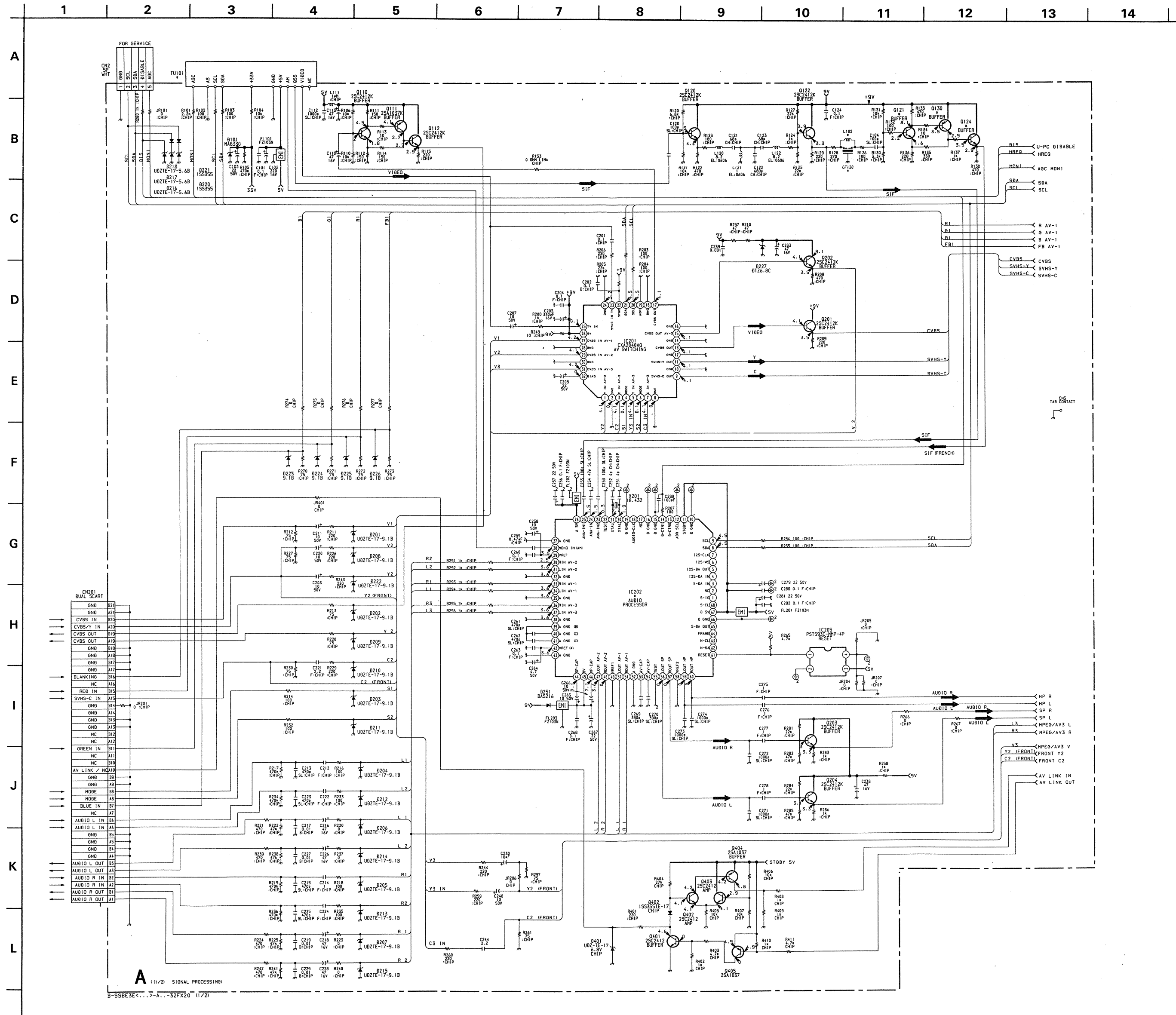

A BOARD - MARK

Ref	32FX20A	32FX20B	32FX20D	32FX20E	32FX20U
IC120	TRAP 6.5 MHZ	TRAP 6.5 MHZ	TRAP 6.5 MHZ	TRAP 6.5 MHZ	-
IC202	MSP3400D-PS-B4-T	MSP3410D-PS-B4-T	MSP3400D-PS-B4-T	MSP3410D-PS-B4-T	MSP3410D-PS-B4-T
IC303	-	TD48395T/N3	TD48395T/N3	TD48395T/N3	-
L102	5.6UH	5.6UH	5.6UH	5.6UH	-
Q121	2SC1623-L5L6	2SC1623-L5L6	2SC1623-L5L6	2SC1623-L5L6	-
Q124	2SC1623-L5L6	2SC1623-L5L6	2SC1623-L5L6	2SC1623-L5L6	-
Q130	2SA1162-G	2SA1162-G	2SA1162-G	2SA1162-G	-
TU101	TUVIFVIF (AEP)	TUVIFVIF (FR)	TUVIFVIF (AEP)	TUVIFVIF (AEP)	TUVIFVIF (UK)

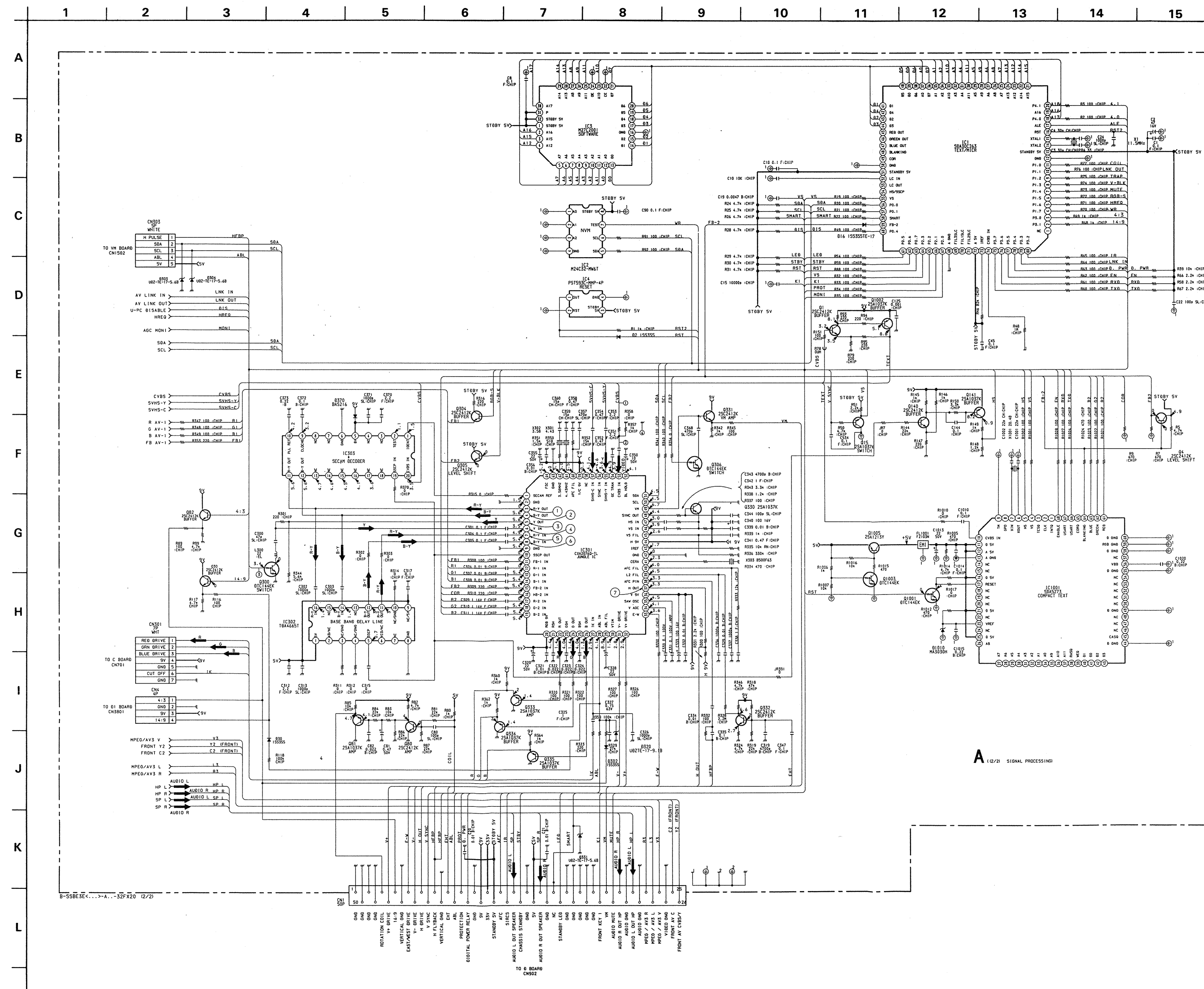

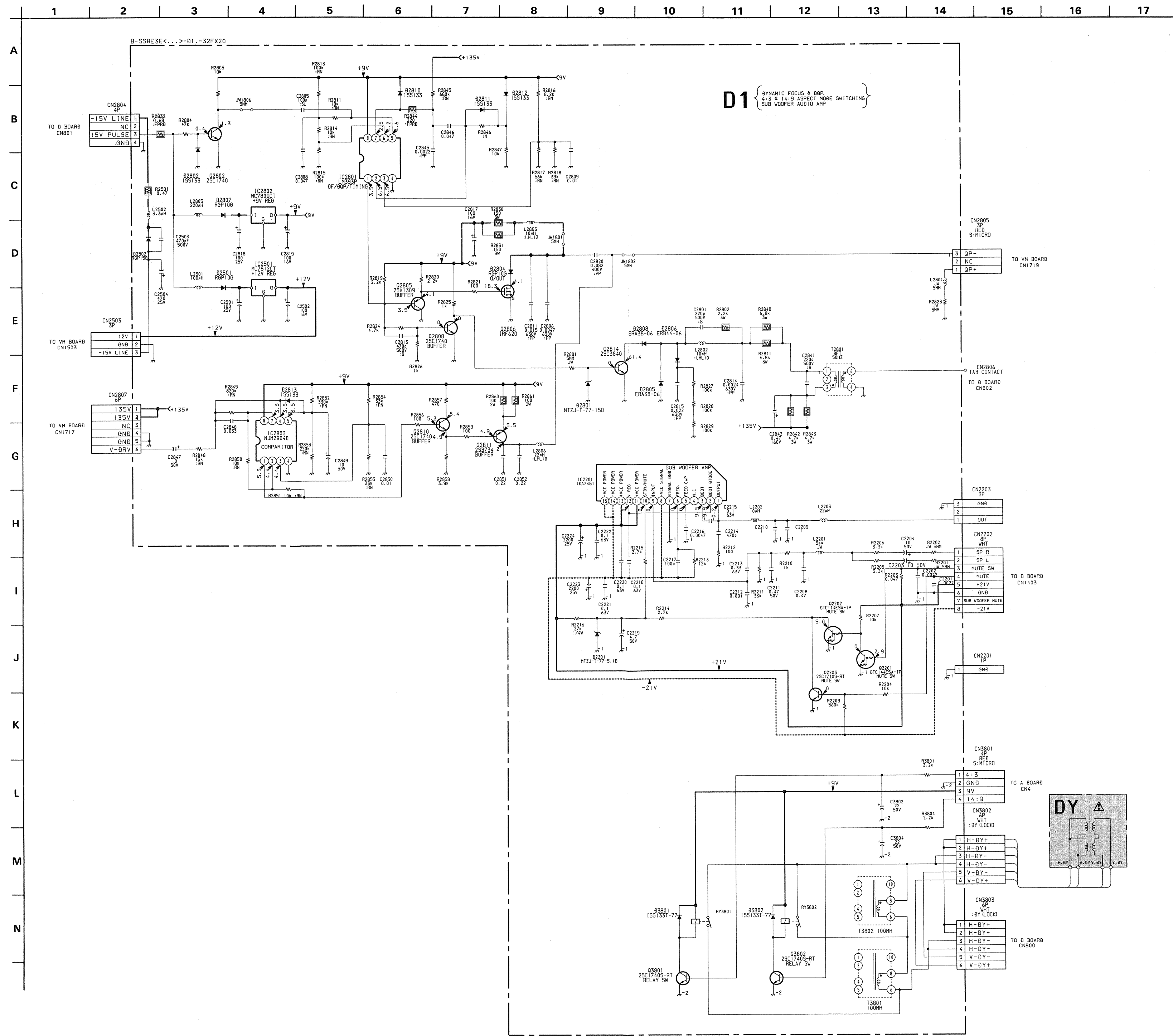

D1 [DYNAMIC FOCUS & DQP 4:3 & 14:9 ASPECT MODE SWITCHING SUB WOOFER AUDIO AMP]

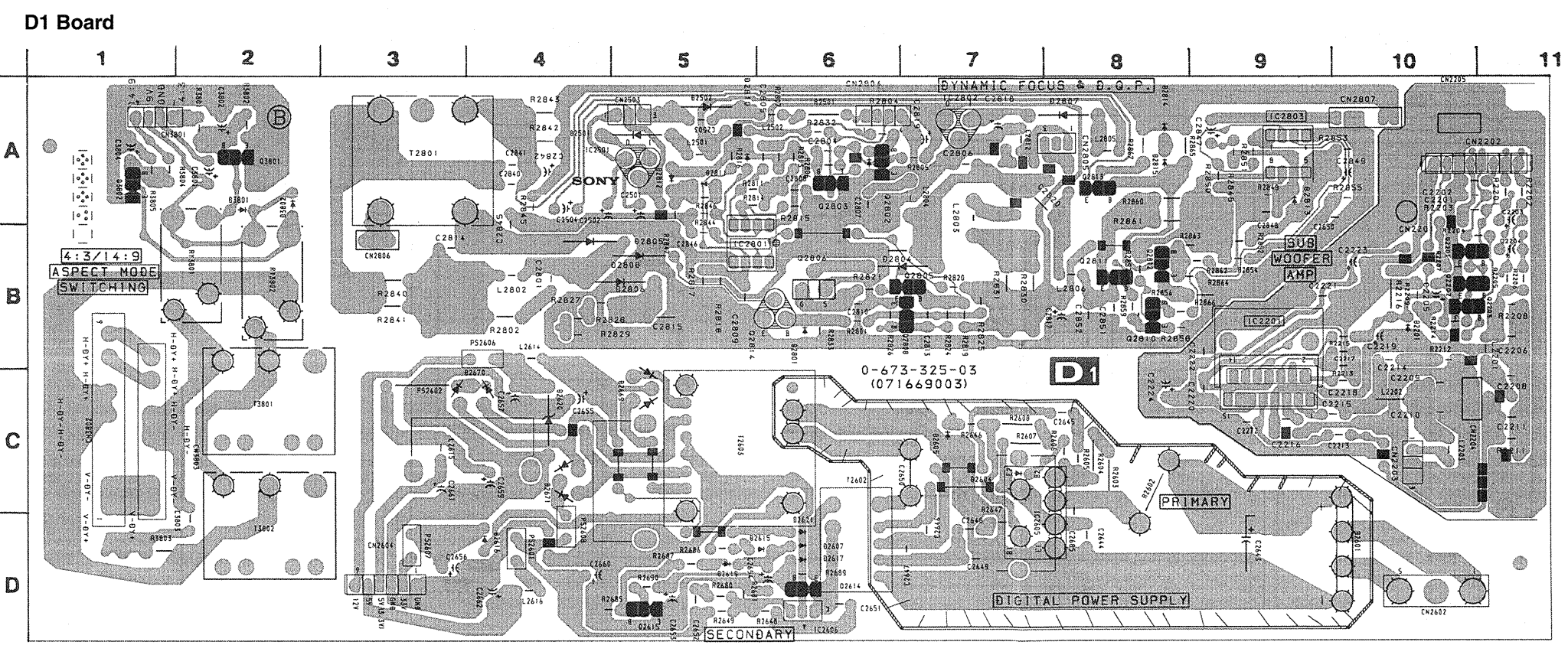

D1 BOARD

IC	DIODE
IC2201 B - 9	D2201 B - 10
IC2501 A - 5	D2501 A - 5
IC2801 B - 5	D2502 A - 5
IC2802 A - 7	D2801 B - 6
IC2803 A - 9	D2802 F - 5
TRANSISTOR	
Q2201 B - 10	D2804 B - 7
Q2202 B - 10	D2805 B - 4
Q2203 B - 10	D2806 B - 5
Q2802 A - 6	D2808 B - 5
Q2805 B - 6	D2810 A - 5
Q2806 B - 6	D2811 F - 6
Q2808 B - 6	D2812 A - 5
Q2810 B - 8	D2813 F - 2
Q2811 B - 8	D3801 A - 2
Q2814 B - 6	D3802 A - 2
Q3801 A - 2	
Q3802 A - 1	

WAVEFORMS A BOARD

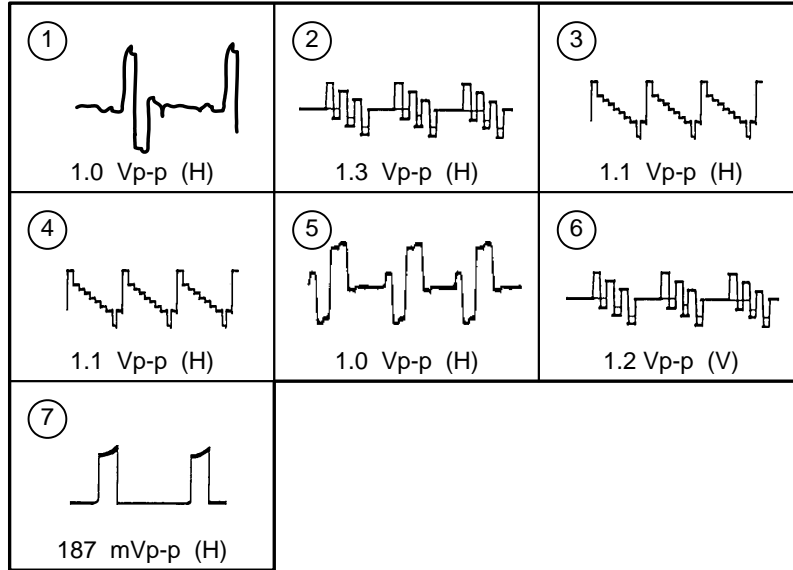

WAVEFORMS C BOARD

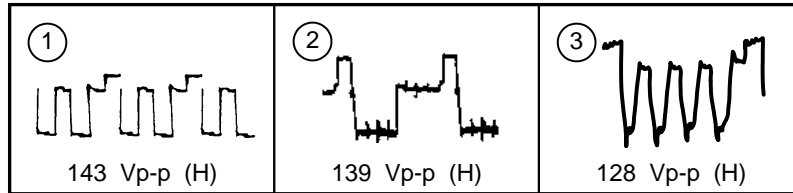

WAVEFORMS VM BOARD

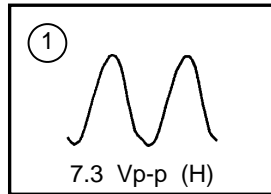

WAVEFORMS D BOARD

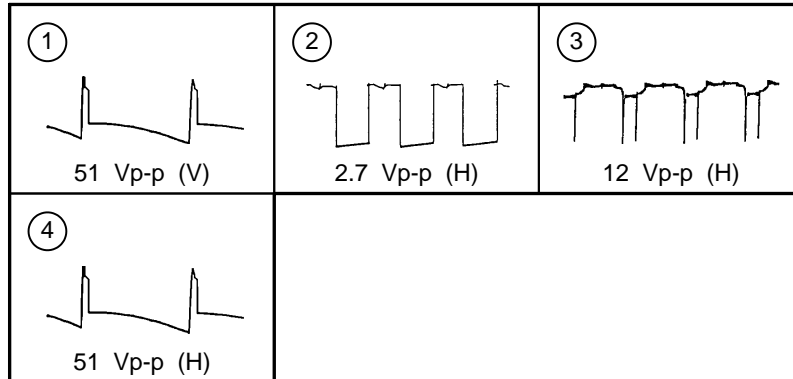

5-4.SEMICONDUCTORS

CXA2040Q-T4

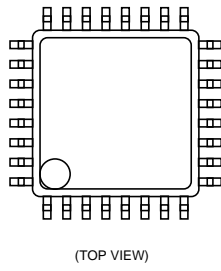

M24C332-MW6T

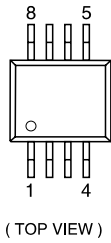

SE135N

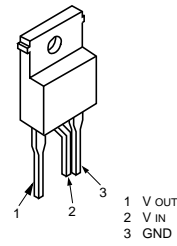

TDA7264

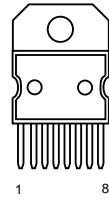

TDA8395T

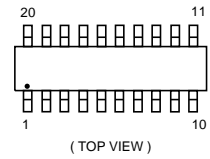

STR-S6709

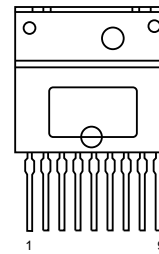

MSP3400D-PS-B4-T
MSP3410D-PS-B4-T

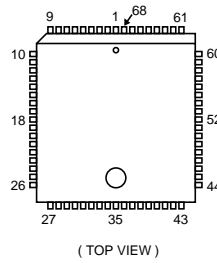

CXA8070P

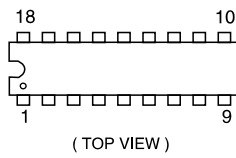

TLP721(D4-)

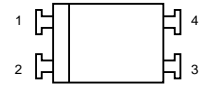

STV9379

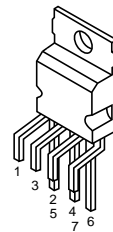

LM393P
M5216P
TDA2822M
TNY253P
 μ PC393C

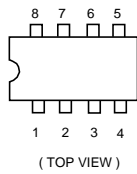

PST593C-MMP-4P

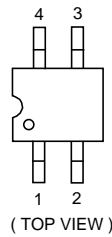

2SA733-K
2SA933AS
2SA933S
2SA1091-O
2SC3502-EF
2SC3601-E
2SC2808STP-R

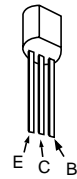

TDA4665T-T

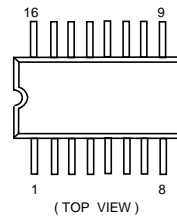

SBX1981-51

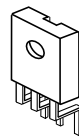

LM2940CT-5.0
LM2940CT
LM2940T-9.0
MCT7809CT
NJM78M09FA
 μ PC2405HF

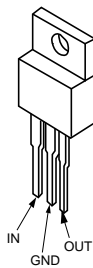

SDA5273M-CP-GEG
SDA3OC263-GEG

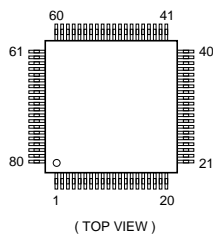

TDA6101Q/N3

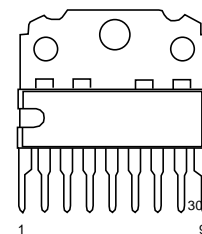

DTA144ES
DTC114ES
DTC143TS
DTC144ESA
2SC1740S-RT

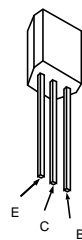

DTC144EKA
2SA1037K
2SA1162-G
2SC2412K

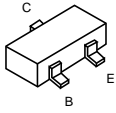

IRF620

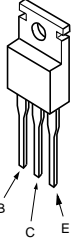

2SC2785-HFE

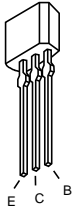

2SA1837

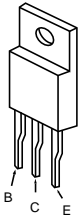

2SC2688-LK
2SC3840(3)

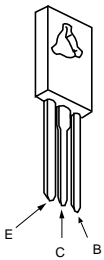

2SC4793

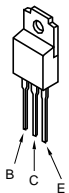

2SC4927-01

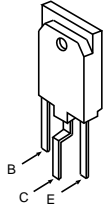

EG-1Z-V1
EGP20G
EL1Z
EM1-V1
EU-1-V1
EU2A
EU2-V1
FML-G12S
GP08D

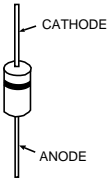

BAS216
DTZ6.8C
DTZ9.1
DTZ33B
RD5.65-B

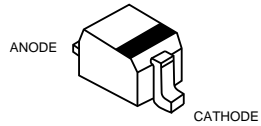

D4SB60L

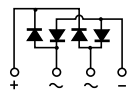
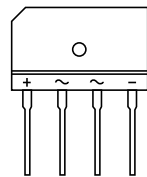

FMS-3FU

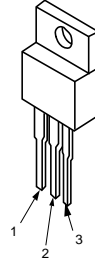

ERA38-06TP1
HZS9.INB2
MTZJ-3.6A
MTZJ-5.1B
MTZJ-5.6B
MTZJ-6.8C
MTZJ-9.1
MTZJ-T-77-9.1A
MTZJ-77-22B

RD3.9ESB2
RD5.1ESB2
RD5.6ESB2
RD6.8ESB2
RD10ESB2
RD15ES-B2
RD39ES-B2
1SS133T-77

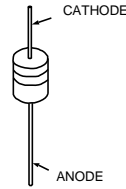

MA3030-H(TX)

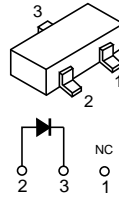

SLA-570KT3F

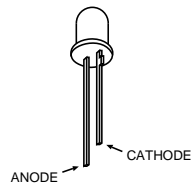

5-5. IC BLOCK DIAGRAMS (1)

A BOARD IC301 CXA2076Q-TL

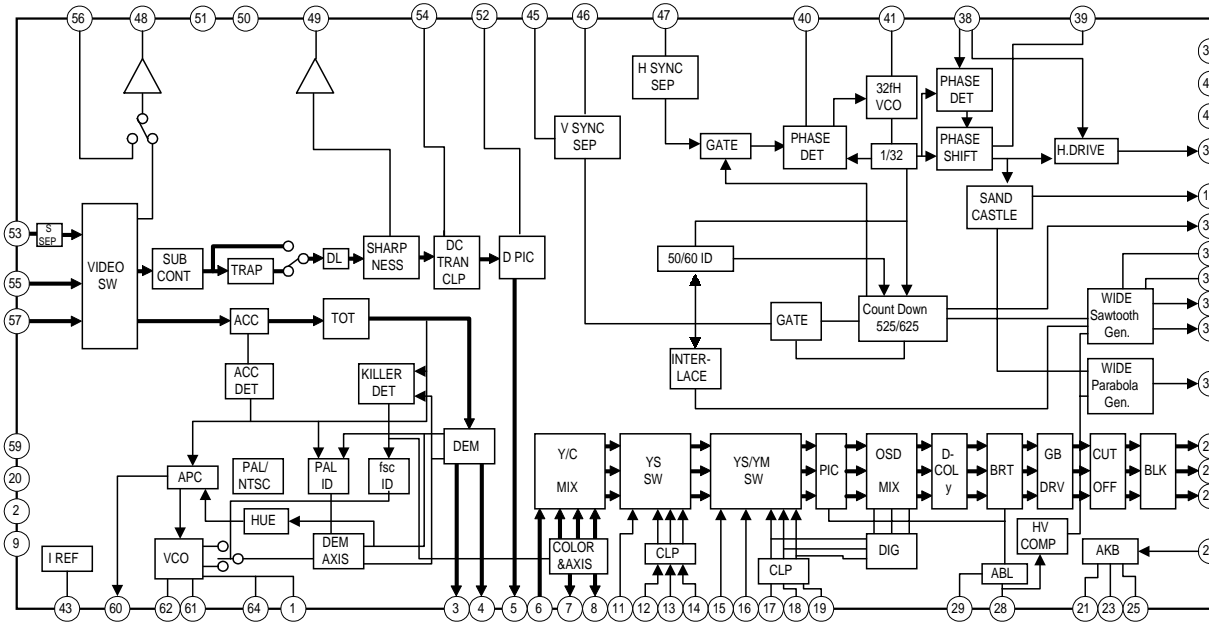

A BOARD IC201 CXA2040AQ

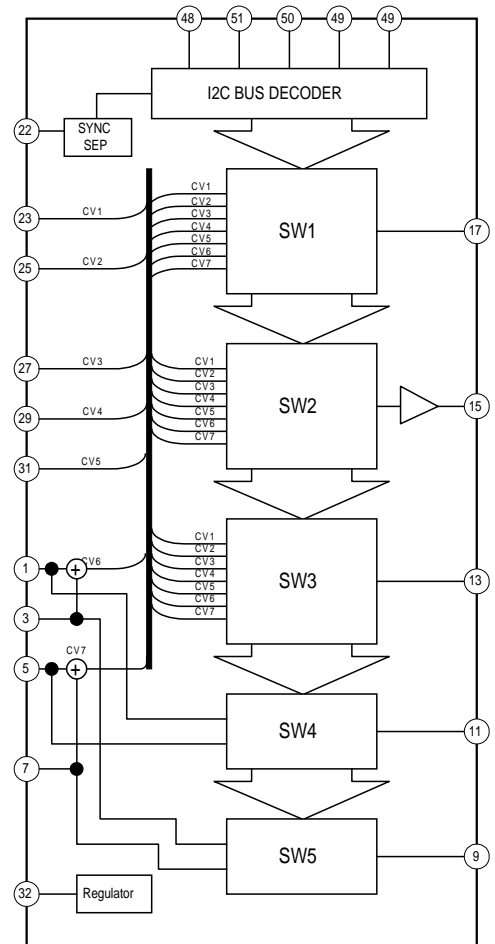

A BOARD IC202 MSP3410D

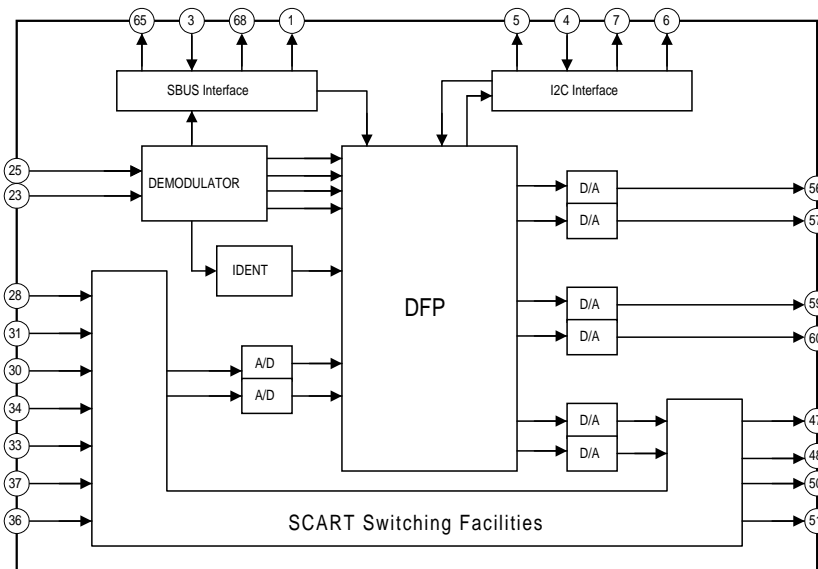

5-5. IC BLOCK DIAGRAMS (2)

A BOARD IC4 PST593C

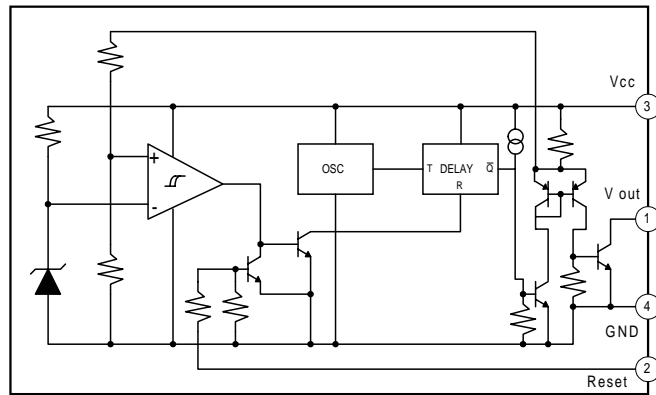

D BOARD IC500 STV9379

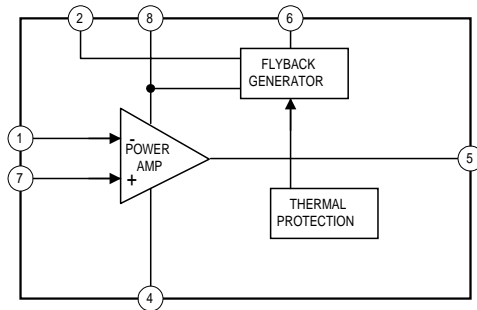

D BOARD IC600 STR-S6709

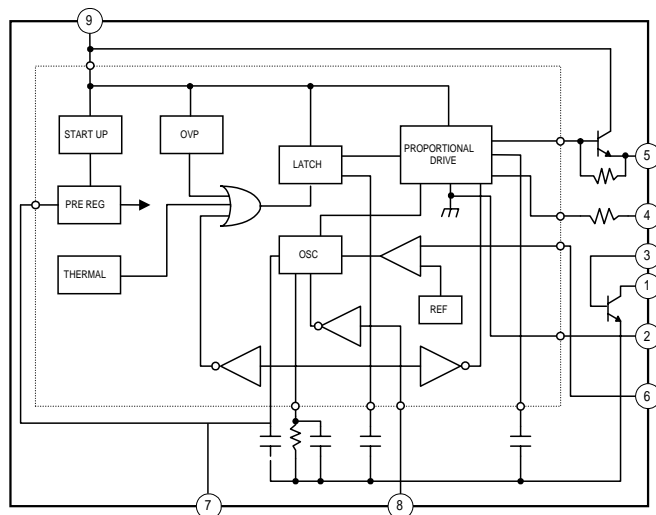

SECTION 6 EXPLODED VIEWS

Note : Les composants identifiés par une trame et par une marque Δ sont d'une importance critique pour la sécurité. Ne les remplacer que par des pièces du numéro spécifié.

Note : The components identified by shading and marked Δ are critical for safety. Replace only with the part numbers specified in the parts list.

NOTE :

- Items with no part number and no description are not stocked because they are seldom required for routine service.
- The construction parts of an assembled part are indicated with a collation number in the remarks column.
- Items marked “*” are not stocked since they are seldom required for routine service. Some delay should be anticipated when ordering these items.

6-1. CHASSIS

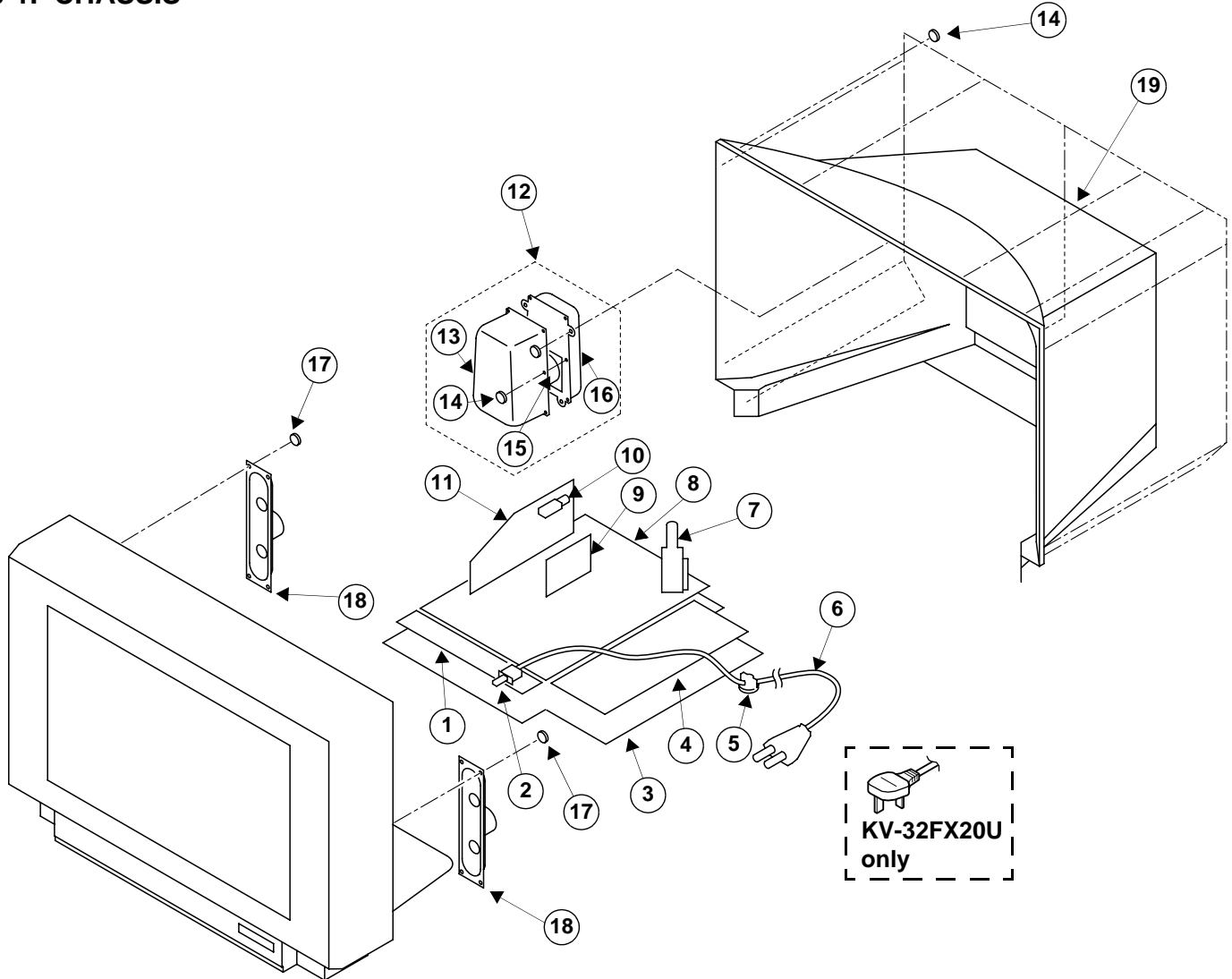

REF. NO.	PART. NO	DESCRIPTION	REMARK	REF. NO.	PART. NO	DESCRIPTION	REMARK
1	*A-1646-183-A	H BOARD, COMPLETE		11	*A-1632-848-A	A BOARD, COMPLETE (KV-32FX20A)	
2	Δ 1-571-433-21	SWITCH, PUSH (AC POWER)			*A-1632-847-A	A BOARD, COMPLETE (KV-32FX20B)	
3	*4-204-752-01	BRACKET, MAIN			*A-1632-846-A	A BOARD, COMPLETE (KV-32FX20D)	
4	*A-1640-350-A	D1 BOARD, COMPLETE			*A-1632-849-A	A BOARD, COMPLETE (KV-32FX20E)	
5	*4-202-531-01	AC CORD LOCK (SC)			*A-1632-850-A	A BOARD, COMPLETE (KV-32FX20U)	
6	Δ 1-783-083-11	CORD POWER (WITH NOISE FILTER) (KV-32FX20A/32FX20B/32FX20D/32FX20E)		12	*A-1674-139-A	SP BLOCK ASSY	13-16
	Δ 1-776-204-12	CORD POWER (FILTER) (KV-32FX20U)		13	*4-204-776-11	BOX, WOOFER	
7	Δ X-4560-158-1	TRANSFORMER ASSY, FLYBACK (NX-4404//U2B4)		14	4-039-358-01	SCREW (4x16), (+) BV TAPPING	
8	*A-1642-252-A	D BOARD, COMPLETE		15	1-529-417-11	SPEAKER (8CM)	
9	*A-1642-251-A	D2 BOARD, COMPLETE		16	4-204-775-11	BAFFLE WOOFER	
10	1-693-338-11	TUNER/VIF (AEP) (KV-32FX20A/32FX20D/ KV-32FX20E)		17	4-384-096-01	SCREW (4x16), TAPPING + P	
	1-693-340-11	TUNER/VIF (FR) (KV-32FX20B)		18	1-529-408-11	SPEAKER 4.2x24CM	
	1-693-339-11	TUNER/VIF (UK) (KV-32FX20U)		19	4-204-735-01	COVER, REAR	

6-2. PICTURE TUBE

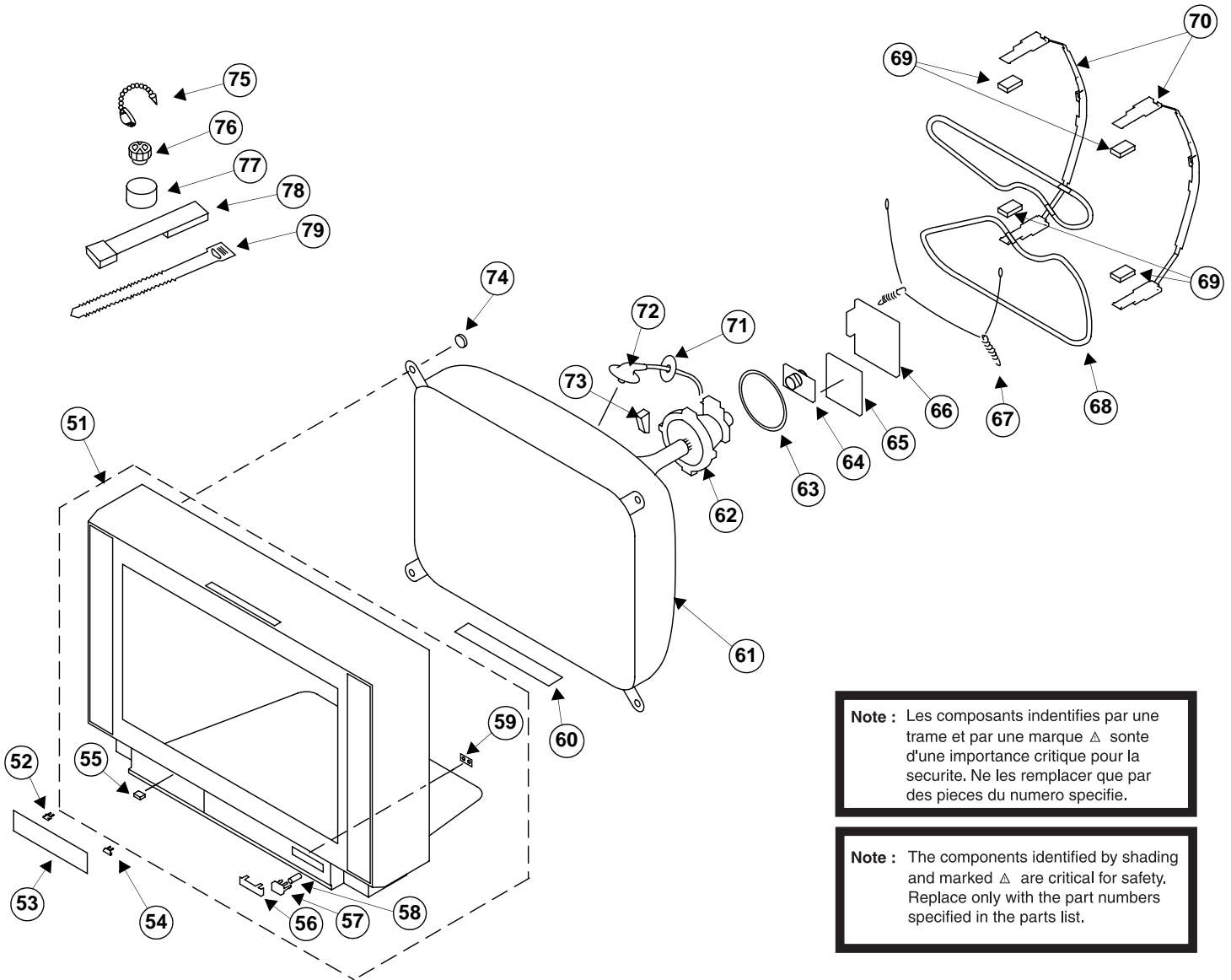

Note : Les composants identifiés par une trame et par une marque Δ sont d'une importance critique pour la sécurité. Ne les remplacer que par des pièces du numéro spécifié.

Note : The components identified by shading and marked Δ are critical for safety. Replace only with the part numbers specified in the parts list.

REF. NO.	PART. NO	DESCRIPTION	REMARK	REF. NO.	PART. NO	DESCRIPTION	REMARK
51	X-4200-488-1	BEZNET ASSY	55-59	66	*A-1638-126-A	C BOARD, COMPLETE	
52	4-045-250-01	DAMPER		67	4-200-433-01	SPRING, EXTENSION	
53	4-204-731-11	DOOR		68	Δ 1-416-769-11	COIL, DEMAGNETIC	
54	4-202-555-01	SHAFT DOOR		69	*4-392-534-31	CUSHION DGC	
55	4-042-192-11	CATCHER, PUSH		70	*4-059-569-01	HOLDER, DGC	
56	4-204-730-11	WINDOW ORNAMENTAL		71	4-202-554-01	HOLDER, HV CABLE	
57	4-204-728-01	BUTTON, POWER		72	Δ 1-251-807-11	CAP ASSY, HIGH VOLTAGE	
58	4-202-964-11	SPRING		73	3-704-495-01	SPACER, DY	
59	4-204-729-01	GUIDE LIGHT		74	4-204-225-01	PT-SCREW	
60	4-203-128-41	SHEET, BLOTTING		75	4-308-870-00	CLIP, LEAD WIRE	
61	Δ 8-735-054-05	PICTURE TUBE (W76LLZ060X) (SD-302)		76	1-452-094-00	MAGNET, ROTATABLE DISK; 15MM \varnothing	
62	Δ 1-451-480-11	DEFLECTION YOKE (Y32RVC2)		77	1-425-032-00	MAGNET, DISK; 10MM \varnothing	
63	1-452-896-11	COIL, NA ROTATION (RT200)		78	X-4387-214-1	PERMALLOY ASSY, CORRECTION	
64	Δ 8-453-011-11	NECK ASSY, NA299-M		79	3-701-007-00	BAND, BINDING	
65	*A-1644-098-A	VM BOARD, COMPLETE					

SECTION 7 ELECTRICAL PARTS LIST

PARTS LISTING TABLE OF CONTENTS

	<u>Page</u>
A BOARD COMMON Parts List : Parts common to all models listed in this manual	76
A BOARD VARIANT Parts List : Parts that belong only to the model specified	
<u>Model</u>	
KV-32FX20A/32FX20B/ KV-32FX20D/32FX20E	82
KV-32FX20U	82
C BOARD COMPLETE Parts List :	82
D1 BOARD COMPLETE Parts List :	83
D2 BOARD COMPLETE Parts List :	85
D BOARD COMPLETE Parts List :	86
VM BOARD COMPLETE Parts List :	90
H BOARD COMPLETE Parts List :	92
MISCELLANEOUS :	93
ACCESSORIES AND PACKAGING MATERIALS :	93

Note : Refer to the designated variant parts list when seeking a part indicated by an asterisk (*)

Parts indicated (#) on the Schematic Diagram are not used in this model and therefore do not appear in the Parts List.



REF.NO.	PART.NO	DESCRIPTION	REMARK
*A-1632-848-A	A Board, Complete	(KV-32FX20A)	
*A-1632-847-A	A Board, Complete	(KV-32FX20B)	
*A-1632-846-A	A Board, Complete	(KV-32FX20D)	
*A-1632-849-A	A Board, Complete	(KV-32FX20E)	
*A-1632-850-A	A Board, Complete	(KV-32FX20U)	

A Board Common Parts

1-750-797-11	SOCKET, PLCC
4-352-844-01	PIN, LEAD, COATING

< CAPACITOR >

C1	1-163-038-91	CERAMIC CHIP 0.1MF	25V
C2	1-104-664-11	ELECT 47MF	20% 16V
C3	1-163-104-00	CERAMIC CHIP 30PF	5% 50V
C4	1-163-104-00	CERAMIC CHIP 30PF	5% 50V
C8	1-163-038-91	CERAMIC CHIP 0.1MF	25V
C10	1-216-073-00	RES,CHIP 10K	5% 1/10W
C15	1-163-021-91	CERAMIC CHIP 0.01MF	10% 50V
C18	1-163-038-91	CERAMIC CHIP 0.1MF	25V
C19	1-163-017-00	CERAMIC CHIP 0.0047MF	10% 50V
C20	1-163-021-91	CERAMIC CHIP 0.01MF	10% 50V
C21	1-163-021-91	CERAMIC CHIP 0.01MF	10% 50V
C22	1-163-117-00	CERAMIC CHIP 100PF	5% 50V
C24	1-163-141-00	CERAMIC CHIP 0.001MF	5% 50V
C45	1-163-038-91	CERAMIC CHIP 0.1MF	25V
C80	1-163-117-00	CERAMIC CHIP 100PF	5% 50V
C81	1-126-959-11	ELECT 0.47MF	20% 50V
C82	1-163-037-11	CERAMIC CHIP 0.022MF	10% 50V
C90	1-163-038-91	CERAMIC CHIP 0.1MF	25V
C101	1-163-038-91	CERAMIC CHIP 0.1MF	25V
C102	1-126-934-11	ELECT 220MF	20% 16V
C103	1-126-965-11	ELECT 22MF	20% 50V
C104	1-163-117-00	CERAMIC CHIP 100PF	5% 50V
C110	1-104-664-11	ELECT 47MF	20% 16V
C112	1-163-141-00	CERAMIC CHIP 0.001MF	5% 50V
C113	1-104-664-11	ELECT 47MF	20% 16V
C120	1-163-117-00	CERAMIC CHIP 100PF	5% 50V
C121	1-163-113-00	CERAMIC CHIP 68PF	5% 50V
C122	1-163-137-00	CERAMIC CHIP 680PF	5% 50V
C123	1-163-113-00	CERAMIC CHIP 68PF	5% 50V
C124	1-163-038-91	CERAMIC CHIP 0.1MF	25V
C125	1-163-141-00	CERAMIC CHIP 0.001MF	5% 50V
C144	1-163-038-91	CERAMIC CHIP 0.1MF	25V
C201	1-164-004-11	CERAMIC CHIP 0.1MF	10% 25V
C202	1-164-004-11	CERAMIC CHIP 0.1MF	10% 25V
C203	1-104-661-91	ELECT 330MF	20% 16V

REF.NO.	PART.NO	DESCRIPTION	REMARK
C204	1-163-038-91	CERAMIC CHIP 0.1MF	25V
C205	1-126-965-11	ELECT 22MF	20% 50V
C207	1-126-964-11	ELECT 10MF	20% 50V
C208	1-126-964-11	ELECT 10MF	20% 50V
C211	1-126-964-11	ELECT 10MF	20% 50V
C212	1-164-346-11	CERAMIC CHIP 1MF	16V
C213	1-163-133-00	CERAMIC CHIP 470PF	5% 50V
C214	1-164-346-11	CERAMIC CHIP 1MF	16V
C215	1-163-133-00	CERAMIC CHIP 470PF	5% 50V
C216	1-104-664-11	ELECT 47MF	20% 16V
C217	1-163-021-91	CERAMIC CHIP 0.01MF	10% 50V
C218	1-104-664-11	ELECT 47MF	20% 16V
C219	1-163-021-91	CERAMIC CHIP 0.01MF	10% 50V
C220	1-126-964-11	ELECT 10MF	20% 50V
C221	1-164-505-11	CERAMIC CHIP 2.2MF	16V
C222	1-164-346-11	CERAMIC CHIP 1MF	16V
C223	1-163-133-00	CERAMIC CHIP 470PF	5% 50V
C224	1-164-346-11	CERAMIC CHIP 1MF	16V
C225	1-163-133-00	CERAMIC CHIP 470PF	5% 50V
C226	1-104-664-11	ELECT 47MF	20% 16V
C227	1-163-021-91	CERAMIC CHIP 0.01MF	10% 50V
C228	1-104-664-11	ELECT 47MF	20% 16V
C229	1-163-021-91	CERAMIC CHIP 0.01MF	10% 50V
C230	1-126-961-91	ELECT 10MF	20% 50V
C233	1-104-664-11	ELECT 47MF	20% 16V
C238	1-104-664-11	ELECT 47MF	20% 16V
C239	1-163-141-00	CERAMIC CHIP 0.001MF	5% 50V
C240	1-126-964-11	ELECT 10MF	20% 50V
C244	1-164-505-11	CERAMIC CHIP 2.2MF	16V
C251	1-163-087-00	CERAMIC CHIP 4PF	0.25PF 50V
C252	1-163-087-00	CERAMIC CHIP 4PF	0.25PF 50V
C253	1-163-117-00	CERAMIC CHIP 100PF	5% 50V
C254	1-163-109-00	CERAMIC CHIP 47PF	5% 50V
C255	1-163-117-00	CERAMIC CHIP 100PF	5% 50V
C256	1-163-038-91	CERAMIC CHIP 0.1MF	25V
C257	1-126-965-11	ELECT 22MF	20% 50V
C258	1-126-964-11	ELECT 10MF	20% 50V
C259	1-164-005-11	CERAMIC CHIP 0.47MF	25V
C260	1-163-038-91	CERAMIC CHIP 0.1MF	25V
C261	1-163-133-00	CERAMIC CHIP 470PF	5% 50V
C262	1-163-133-00	CERAMIC CHIP 470PF	5% 50V
C263	1-163-038-91	CERAMIC CHIP 0.1MF	25V
C264	1-126-963-11	ELECT 4.7MF	20% 50V
C265	1-126-964-11	ELECT 10MF	20% 50V
C266	1-126-964-11	ELECT 10MF	20% 50V
C267	1-126-965-11	ELECT 22MF	20% 50V
C268	1-163-038-91	CERAMIC CHIP 0.1MF	25V

REF. NO.	PART.NO	DESCRIPTION	REMARK	REF. NO.	PART.NO	DESCRIPTION	REMARK
C269	1-163-131-00	CERAMIC CHIP 390PF	5% 50V	C336	1-163-009-11	CERAMIC CHIP 0.001MF	10% 50V
C270	1-163-131-00	CERAMIC CHIP 390PF	5% 50V	C337	1-163-009-11	CERAMIC CHIP 0.001MF	10% 50V
C271	1-163-141-00	CERAMIC CHIP 0.001MF	5% 50V	C338	1-164-346-11	CERAMIC CHIP 1MF	16V
C272	1-163-141-00	CERAMIC CHIP 0.001MF	5% 50V	C339	1-163-021-91	CERAMIC CHIP 0.01MF	10% 50V
C273	1-163-141-00	CERAMIC CHIP 0.001MF	5% 50V	C340	1-126-933-11	ELECT 100MF	20% 16V
C274	1-163-141-00	CERAMIC CHIP 0.001MF	5% 50V	C341	1-164-005-11	CERAMIC CHIP 0.47MF	25V
C275	1-164-346-11	CERAMIC CHIP 1MF	16V	C342	1-164-346-11	CERAMIC CHIP 1MF	16V
C276	1-164-346-11	CERAMIC CHIP 1MF	16V	C343	1-163-017-00	CERAMIC CHIP 0.0047MF	10% 50V
C277	1-164-346-11	CERAMIC CHIP 1MF	16V	C347	1-164-004-11	CERAMIC CHIP 0.1MF	10% 25V
C278	1-164-346-11	CERAMIC CHIP 1MF	16V	C348	1-163-133-00	CERAMIC CHIP 470PF	5% 50V
C279	1-126-965-11	ELECT 22MF	20% 50V	C350	1-126-964-11	ELECT 10MF	20% 50V
C280	1-163-038-91	CERAMIC CHIP 0.1MF	25V	C351	1-164-505-11	CERAMIC CHIP 2.2MF	16V
C281	1-126-965-11	ELECT 22MF	20% 50V	C352	1-164-005-11	CERAMIC CHIP 0.47MF	25V
C282	1-163-038-91	CERAMIC CHIP 0.1MF	25V	C353	1-164-505-11	CERAMIC CHIP 2.2MF	16V
C288	1-163-117-91	CERAMIC CHIP 100PF	5% 50V	C354	1-164-005-11	CERAMIC CHIP 0.47MF	25V
C300	1-163-109-00	CERAMIC CHIP 47PF	5% 50V	C355	1-126-965-11	ELECT 22MF	20% 50V
C301	1-163-038-91	CERAMIC CHIP 0.1MF	25V	C356	1-163-021-91	CERAMIC CHIP 0.01MF	10% 50V
C302	1-163-141-00	CERAMIC CHIP 0.001MF	5% 50V	C357	1-163-133-00	CERAMIC CHIP 470PF	5% 50V
C303	1-163-141-00	CERAMIC CHIP 0.001MF	5% 50V	C358	1-164-005-11	CERAMIC CHIP 0.47MF	25V
C304	1-163-038-91	CERAMIC CHIP 0.1MF	25V	C359	1-163-231-11	CERAMIC CHIP 15PF	5% 50V
C305	1-163-038-91	CERAMIC CHIP 0.1MF	25V	C360	1-163-231-11	CERAMIC CHIP 15PF	5% 50V
C306	1-163-021-91	CERAMIC CHIP 0.01MF	10% 50V	C370	1-164-505-11	CERAMIC CHIP 2.2MF	16V
C307	1-163-021-91	CERAMIC CHIP 0.01MF	10% 50V	C371	1-163-141-00	CERAMIC CHIP 0.001MF	5% 50V
C308	1-163-021-91	CERAMIC CHIP 0.01MF	10% 50V	C372	1-164-004-11	CERAMIC CHIP 0.1MF	10% 25V
C309	1-164-346-11	CERAMIC CHIP 1MF	16V	C373	1-164-489-11	CERAMIC CHIP 0.22MF	10% 16V
C310	1-164-346-11	CERAMIC CHIP 1MF	16V	C534	1-163-038-91	CERAMIC CHIP 0.1MF	25V
C311	1-164-346-11	CERAMIC CHIP 1MF	16V	C1001	1-163-235-11	CERAMIC CHIP 22PF	5% 50V
C312	1-164-505-11	CERAMIC CHIP 2.2MF	16V	C1002	1-163-235-11	CERAMIC CHIP 22PF	5% 50V
C315	1-216-295-91	SHORT 0		C1010	1-163-038-91	CERAMIC CHIP 0.1MF	25V
C317	1-163-038-91	CERAMIC CHIP 0.1MF	25V	C1013	1-126-965-11	ELECT 22MF	20% 50V
C319	1-163-017-00	CERAMIC CHIP 0.0047MF	10% 50V	C1014	1-163-038-91	CERAMIC CHIP 0.1MF	25V
C320	1-126-965-11	ELECT 22MF	20% 50V	C1015	1-164-489-11	CERAMIC CHIP 0.22MF	10% 16V
C321	1-163-021-91	CERAMIC CHIP 0.01MF	10% 50V	C1020	1-164-489-11	CERAMIC CHIP 0.22MF	10% 16V
C322	1-163-037-11	CERAMIC CHIP 0.022MF	10% 50V			< CONNECTOR >	
C323	1-163-037-11	CERAMIC CHIP 0.022MF	10% 50V	CN1	1-695-302-11	CONNECTOR, BOARD TO BOARD 50P	
C324	1-163-037-11	CERAMIC CHIP 0.022MF	10% 50V	CN2	*1-564-508-11	PLUG, CONNECTOR 5P	
C325	1-164-346-11	CERAMIC CHIP 1MF	16V	CN4	*1-568-879-11	PIN, CONNECTOR 4P	
C326	1-163-141-00	CERAMIC CHIP 0.001MF	5% 50V	CN5	1-695-915-11	TAB (CONTACT)	
C327	1-130-770-00	FILM 0.15MF	5% 63V	CN201	1-766-296-21	CONNECTOR, DUAL SCART	
C328	1-126-965-11	ELECT 22MF	20% 50V	CN301	*1-568-882-51	PIN, CONNECTOR 7P	
C329	1-163-021-91	CERAMIC CHIP 0.01MF	10% 50V	CN303	*1-568-880-51	PIN, CONNECTOR 5P	
C330	1-137-581-11	FILM 0.1MF	5% 100V			< DIODE >	
C331	1-137-581-11	FILM 0.1MF	5% 100V	D2	8-719-988-61	DIODE 1SS355TE-17	
C332	1-163-021-91	CERAMIC CHIP 0.01MF	10% 50V	D16	8-719-988-61	DIODE 1SS355TE-17	
C333	1-126-933-11	ELECT 100MF	20% 16V	D30	8-719-988-61	DIODE 1SS355TE-17	
C334	1-163-021-91	CERAMIC CHIP 0.01MF	10% 50V				
C335	1-164-004-11	CERAMIC CHIP 0.1MF	10% 25V				



REF.NO.	PART.NO	DESCRIPTION	REMARK	REF.NO.	PART.NO	DESCRIPTION	REMARK
D101	8-719-977-81	DIODE DTZ33B				< IC >	
D201	8-719-069-60	DIODE UDZS-TE17-9.1B		IC1	8-759-376-77	IC SDA30C263-GEG	
D202	8-719-069-60	DIODE UDZS-TE17-9.1B		IC2	8-759-524-94	IC M24C32-MW6T	
D203	8-719-069-60	DIODE UDZS-TE17-9.1B		IC3	8-759-641-72	IC M27C2001	
D204	8-719-069-60	DIODE UDZS-TE17-9.1B		IC4	8-759-394-57	IC PST593C-MMP-4P	
D205	8-719-069-60	DIODE UDZS-TE17-9.1B		IC201	8-752-081-26	IC CXA2040AQ-T4	
D206	8-719-069-60	DIODE UDZS-TE17-9.1B					
D207	8-719-069-60	DIODE UDZS-TE17-9.1B		IC205	8-759-394-57	IC PST593C-MMP-4P	
D208	8-719-069-60	DIODE UDZS-TE17-9.1B		IC301	8-752-081-43	IC CXA2076Q-TL	
D209	8-719-069-60	DIODE UDZS-TE17-9.1B		IC302	8-759-565-20	IC TDA4665T/V5-118	
D210	8-719-069-60	DIODE UDZS-TE17-9.1B		IC1001	8-759-584-20	IC SDA5273	
D211	8-719-069-60	DIODE UDZS-TE17-9.1B				< COIL >	
D212	8-719-069-60	DIODE UDZS-TE17-9.1B		L111	1-410-993-22	INDUCTOR CHIP 1UH	
D213	8-719-069-60	DIODE UDZS-TE17-9.1B		L120	1-408-602-31	INDUCTOR 8.2UH	
D214	8-719-069-60	DIODE UDZS-TE17-9.1B		L121	1-408-591-21	INDUCTOR 1UH	
D215	8-719-069-60	DIODE UDZS-TE17-9.1B		L122	1-408-602-31	INDUCTOR 8.2UH	
D216	8-719-069-55	DIODE UDZS-TE17-5.6B		L300	1-408-607-21	INDUCTOR 22UH	
D217	8-719-069-55	DIODE UDZS-TE17-5.6B				< TRANSISTOR >	
D218	8-719-069-55	DIODE UDZS-TE17-5.6B		Q1	8-729-120-28	TRANSISTOR 2SC1623-L5L6	
D220	8-719-988-61	DIODE 1SS355TE-17		Q4	8-729-120-28	TRANSISTOR 2SC1623-L5L6	
D221	8-719-988-61	DIODE 1SS355TE-17		Q15	8-729-026-49	TRANSISTOR 2SA1037AK	
D222	8-719-069-60	DIODE UDZS-TE17-9.1B		Q30	8-729-120-28	TRANSISTOR 2SC1623-L5L6	
D223	8-719-069-60	DIODE UDZS-TE17-9.1B		Q80	8-729-120-28	TRANSISTOR 2SC1623-L5L6	
D224	8-719-069-60	DIODE UDZS-TE17-9.1B					
D225	8-719-069-60	DIODE UDZS-TE17-9.1B		Q81	8-729-026-49	TRANSISTOR 2SA1037AK	
D226	8-719-069-60	DIODE UDZS-TE17-9.1B		Q82	8-729-120-28	TRANSISTOR 2SC1623-L5L6	
D227	8-719-977-13	DIODE DTZ6.8C		Q110	8-729-120-28	TRANSISTOR 2SC1623-L5L6	
D251	8-719-047-16	DIODE BAS216		Q111	8-729-026-49	TRANSISTOR 2SA1037AK	
D302	8-719-988-61	DIODE 1SS355TE-17		Q112	8-729-120-28	TRANSISTOR 2SC1623-L5L6	
D303	8-719-069-55	DIODE UDZS-TE17-5.6B					
D304	8-719-069-55	DIODE UDZS-TE17-5.6B		Q120	8-729-120-28	TRANSISTOR 2SC1623-L5L6	
D320	8-719-069-60	DIODE UDZS-TE17-9.1B		Q122	8-729-120-28	TRANSISTOR 2SC1623-L5L6	
D331	8-719-069-55	DIODE UDZS-TE17-5.6B		Q140	8-729-120-28	TRANSISTOR 2SC1623-L5L6	
D370	8-719-047-16	DIODE BAS216		Q141	8-729-026-49	TRANSISTOR 2SA1037AK	
D401	8-719-069-57	DIODE UDZS-TE17-6.8B		Q201	8-729-120-28	TRANSISTOR 2SC1623-L5L6	
D402	8-719-988-61	DIODE 1SS355TE-17					
D1010	8-719-036-58	DIODE MA3030-H(TX)		Q202	8-729-120-28	TRANSISTOR 2SC1623-L5L6	
		< ENCAPSULATED FILTER >		Q203	8-729-120-28	TRANSISTOR 2SC1623-L5L6	
FL101	1-236-071-11	ENCAPSULATED COMPONENT		Q204	8-729-120-28	TRANSISTOR 2SC1623-L5L6	
FL201	1-236-071-11	ENCAPSULATED COMPONENT		Q300	1-801-806-11	TRANSISTOR DTC144EKA	
FL202	1-236-071-11	ENCAPSULATED COMPONENT		Q304	8-729-120-28	TRANSISTOR 2SC1623-L5L6	
FL203	1-236-071-11	ENCAPSULATED COMPONENT					
FL1001	1-236-071-11	ENCAPSULATED COMPONENT		Q305	8-729-120-28	TRANSISTOR 2SC1623-L5L6	
				Q306	1-801-806-11	TRANSISTOR DTC144EKA	
				Q330	8-729-026-49	TRANSISTOR 2SA1037AK	
				Q331	8-729-120-28	TRANSISTOR 2SC1623-L5L6	
				Q332	8-729-120-28	TRANSISTOR 2SC1623-L5L6	
				Q333	8-729-026-49	TRANSISTOR 2SA1037AK	
				Q334	8-729-026-49	TRANSISTOR 2SA1037AK	
				Q335	8-729-026-49	TRANSISTOR 2SA1037AK	



REF. NO.	PART.NO	DESCRIPTION	REMARK	REF. NO.	PART.NO	DESCRIPTION	REMARK
Q401	8-729-120-28	TRANSISTOR 2SC1623-L5L6		R54	1-216-025-91	RES,CHIP 100 5%	1/10W
Q402	8-729-120-28	TRANSISTOR 2SC1623-L5L6		R58	1-216-057-00	RES,CHIP 2.2K 5%	1/10W
Q403	8-729-120-28	TRANSISTOR 2SC1623-L5L6		R59	1-216-025-91	RES,CHIP 100 5%	1/10W
Q404	8-729-026-49	TRANSISTOR 2SA1037AK		R60	1-216-025-91	RES,CHIP 100 5%	1/10W
Q405	8-729-026-49	TRANSISTOR 2SA1037AK		R61	1-216-025-91	RES,CHIP 100 5%	1/10W
Q1001	1-801-806-11	TRANSISTOR DTC144EKA		R62	1-216-025-91	RES,CHIP 100 5%	1/10W
Q1002	8-729-026-49	TRANSISTOR 2SA1037AK		R63	1-216-025-91	RES,CHIP 100 5%	1/10W
Q1003	1-729-901-22	TRANSISTOR DTC144EK		R64	1-216-025-91	RES,CHIP 100 5%	1/10W
Q1005	8-729-209-73	TRANSISTOR 2SA1213Y		R65	1-216-025-91	RES,CHIP 100 5%	1/10W
		< RESISTOR >		R66	1-216-057-00	RES,CHIP 2.2K 5%	1/10W
JR7	1-216-295-91	SHORT 0		R67	1-216-057-00	RES,CHIP 2.2K 5%	1/10W
JR101	1-216-295-91	SHORT 0		R68	1-216-049-91	RES,CHIP 1K 5%	1/10W
JR204	1-216-295-91	SHORT 0		R69	1-216-049-91	RES,CHIP 1K 5%	1/10W
JR205	1-216-295-91	SHORT 0		R70	1-216-025-91	RES,CHIP 100 5%	1/10W
JR206	1-216-295-91	SHORT 0		R71	1-216-025-91	RES,CHIP 100 5%	1/10W
JR207	1-216-295-91	SHORT 0		R72	1-216-025-91	RES,CHIP 100 5%	1/10W
JR391	1-216-295-91	SHORT 0		R73	1-216-025-91	RES,CHIP 100 5%	1/10W
JR401	1-216-295-91	SHORT 0		R74	1-216-025-91	RES,CHIP 100 5%	1/10W
R1	1-216-049-91	RES,CHIP 1K 5%	1/10W	R75	1-216-025-91	RES,CHIP 100 5%	1/10W
R2	1-216-025-91	RES,CHIP 100 5%	1/10W	R76	1-216-025-91	RES,CHIP 100 5%	1/10W
R3	1-216-025-91	RES,CHIP 100 5%	1/10W	R77	1-216-025-91	RES,CHIP 100 5%	1/10W
R4	1-216-013-00	RES,CHIP 33 5%	1/10W	R78	1-414-233-22	INDUCTOR CHIP 00H	
R5	1-216-065-91	RES,CHIP 4.7K 5%	1/10W	R79	1-216-033-00	RES,CHIP 220 5%	1/10W
R7	1-216-041-00	RES,CHIP 470 5%	1/10W	R80	1-216-049-91	RES,CHIP 1K 5%	1/10W
R9	1-216-041-00	RES,CHIP 470 5%	1/10W	R81	1-216-081-00	RES,CHIP 22K 5%	1/10W
R19	1-216-025-91	RES,CHIP 100 5%	1/10W	R82	1-216-065-91	RES,CHIP 4.7K 5%	1/10W
R20	1-216-025-91	RES,CHIP 100 5%	1/10W	R83	1-216-073-00	RES,CHIP 10K 5%	1/10W
R21	1-216-025-91	RES,CHIP 100 5%	1/10W	R84	1-216-081-00	RES,CHIP 22K 5%	1/10W
R22	1-216-025-91	RES,CHIP 100 5%	1/10W	R85	1-216-073-00	RES,CHIP 10K 5%	1/10W
R24	1-216-065-91	RES,CHIP 4.7K 5%	1/10W	R86	1-216-081-00	RES,CHIP 22K 5%	1/10W
R25	1-216-065-91	RES,CHIP 4.7K 5%	1/10W	R87	1-216-081-00	RES,CHIP 22K 5%	1/10W
R26	1-216-065-91	RES,CHIP 4.7K 5%	1/10W	R88	1-216-025-91	RES,CHIP 100 5%	1/10W
R28	1-216-065-91	RES,CHIP 4.7K 5%	1/10W	R89	1-216-025-91	RES,CHIP 100 5%	1/10W
R29	1-216-065-91	RES,CHIP 4.7K 5%	1/10W	R91	1-216-025-91	RES,CHIP 100 5%	1/10W
R30	1-216-065-91	RES,CHIP 4.7K 5%	1/10W	R92	1-216-025-91	RES,CHIP 100 5%	1/10W
R31	1-216-065-91	RES,CHIP 4.7K 5%	1/10W	R93	1-216-033-00	RES,CHIP 220 5%	1/10W
R32	1-216-025-91	RES,CHIP 100 5%	1/10W	R94	1-216-033-00	RES,CHIP 220 5%	1/10W
R33	1-216-025-91	RES,CHIP 100 5%	1/10W	R95	1-216-033-00	RES,CHIP 220 5%	1/10W
R34	1-216-025-91	RES,CHIP 100 5%	1/10W	R99	1-216-065-91	RES,CHIP 4.7K 5%	1/10W
R35	1-216-025-91	RES,CHIP 100 5%	1/10W	R101	1-216-057-00	RES,CHIP 2.2K 5%	1/10W
R39	1-216-073-00	RES,CHIP 10K 5%	1/10W	R102	1-216-025-91	RES,CHIP 100 5%	1/10W
R46	1-216-095-00	RES,CHIP 82K 5%	1/10W	R103	1-216-025-91	RES,CHIP 100 5%	1/10W
R48	1-216-121-91	RES,CHIP 1M 5%	1/10W	R104	1-216-073-00	RES,CHIP 10K 5%	1/10W
R49	1-216-025-91	RES,CHIP 100 5%	1/10W	R105	1-216-113-00	RES,CHIP 470K 5%	1/10W
R50	1-216-065-91	RES,CHIP 4.7K 5%	1/10W	R106	1-216-073-00	RES,CHIP 10K 5%	1/10W
R51	1-216-057-00	RES,CHIP 2.2K 5%	1/10W	R110	1-216-073-00	RES,CHIP 10K 5%	1/10W
				R111	1-216-029-00	RES,CHIP 150 5%	1/10W



REF.NO.	PART.NO	DESCRIPTION	REMARK	REF.NO.	PART.NO	DESCRIPTION	REMARK
R112	1-216-029-00	RES,CHIP	150 5% 1/10W	R216	1-216-025-91	RES,CHIP	100 5% 1/10W
R113	1-216-001-00	RES,CHIP	10 5% 1/10W	R217	1-216-113-00	RES,CHIP	470K 5% 1/10W
R114	1-216-029-00	RES,CHIP	150 5% 1/10W	R218	1-216-025-91	RES,CHIP	100 5% 1/10W
R115	1-216-033-00	RES,CHIP	220 5% 1/10W	R219	1-216-113-00	RES,CHIP	470K 5% 1/10W
R116	1-216-025-91	RES,CHIP	100 5% 1/10W	R220	1-216-295-91	SHORT	0
R117	1-216-065-91	RES,CHIP	4.7K 5% 1/10W	R221	1-216-041-00	RES,CHIP	470 5% 1/10W
R118	1-216-097-91	RES,CHIP	100K 5% 1/10W	R222	1-216-089-91	RES,CHIP	47K 5% 1/10W
R120	1-216-069-00	RES,CHIP	6.8K 5% 1/10W	R223	1-216-295-91	SHORT	0
R121	1-216-073-00	RES,CHIP	10K 5% 1/10W	R224	1-216-041-00	RES,CHIP	470 5% 1/10W
R122	1-216-041-00	RES,CHIP	470 5% 1/10W	R225	1-216-089-91	RES,CHIP	47K 5% 1/10W
R123	1-216-031-00	RES,CHIP	180 5% 1/10W	R226	1-216-033-00	RES,CHIP	220 5% 1/10W
R124	1-216-049-91	RES,CHIP	1K 5% 1/10W	R227	1-216-022-00	RES,CHIP	75 5% 1/10W
R125	1-216-081-00	RES,CHIP	22K 5% 1/10W	R228	1-216-022-00	RES,CHIP	75 5% 1/10W
R126	1-216-025-91	RES,CHIP	100 5% 1/10W	R229	1-216-033-00	RES,CHIP	220 5% 1/10W
R127	1-216-081-00	RES,CHIP	22K 5% 1/10W	R230	1-216-022-00	RES,CHIP	75 5% 1/10W
R128	1-216-035-00	RES,CHIP	270 5% 1/10W	R232	1-216-025-91	RES,CHIP	100 5% 1/10W
R129	1-216-033-00	RES,CHIP	220 5% 1/10W	R233	1-216-025-91	RES,CHIP	100 5% 1/10W
R130	1-216-061-00	RES,CHIP	3.3K 5% 1/10W	R234	1-216-113-00	RES,CHIP	470K 5% 1/10W
R131	1-216-073-00	RES,CHIP	10K 5% 1/10W	R235	1-216-025-91	RES,CHIP	100 5% 1/10W
R132	1-216-025-91	RES,CHIP	100 5% 1/10W	R236	1-216-113-00	RES,CHIP	470K 5% 1/10W
R133	1-216-041-00	RES,CHIP	470 5% 1/10W	R237	1-216-295-91	SHORT	0
R134	1-216-001-00	RES,CHIP	10 5% 1/10W	R238	1-216-089-91	RES,CHIP	47K 5% 1/10W
R135	1-216-037-00	RES,CHIP	330 5% 1/10W	R239	1-216-041-00	RES,CHIP	470 5% 1/10W
R136	1-216-033-00	RES,CHIP	220 5% 1/10W	R240	1-216-295-91	SHORT	0
R137	1-216-049-91	RES,CHIP	1K 5% 1/10W	R241	1-216-089-91	RES,CHIP	47K 5% 1/10W
R138	1-216-041-00	RES,CHIP	470 5% 1/10W	R242	1-216-041-00	RES,CHIP	470 5% 1/10W
R144	1-216-081-00	RES,CHIP	22K 5% 1/10W	R243	1-216-033-00	RES,CHIP	220 5% 1/10W
R145	1-216-049-91	RES,CHIP	1K 5% 1/10W	R244	1-216-033-00	RES,CHIP	220 5% 1/10W
R146	1-216-049-91	RES,CHIP	1K 5% 1/10W	R249	1-216-001-00	RES,CHIP	10 5% 1/10W
R147	1-216-033-00	RES,CHIP	220 5% 1/10W	R255	1-216-025-91	RES,CHIP	100 5% 1/10W
R148	1-216-051-00	RES,CHIP	1.2K 5% 1/10W	R256	1-216-025-91	RES,CHIP	100 5% 1/10W
R149	1-216-049-91	RES,CHIP	1K 5% 1/10W	R257	1-216-017-91	RES,CHIP	47 5% 1/10W
R150	1-216-061-00	RES,CHIP	3.3K 5% 1/10W	R258	1-216-049-91	RES,CHIP	1K 5% 1/10W
R151	1-216-025-91	RES,CHIP	100 5% 1/10W	R259	1-216-033-00	RES,CHIP	220 5% 1/10W
R153	1-216-295-91	SHORT	0	R260	1-216-033-00	RES,CHIP	220 5% 1/10W
R200	1-216-049-91	RES,CHIP	1K 5% 1/10W	R261	1-216-022-00	RES,CHIP	75 5% 1/10W
R203	1-216-025-91	RES,CHIP	100 5% 1/10W	R265	1-216-065-91	RES,CHIP	4.7K 5% 1/10W
R204	1-216-025-91	RES,CHIP	100 5% 1/10W	R266	1-216-295-91	SHORT	0
R205	1-216-081-00	RES,CHIP	22K 5% 1/10W	R267	1-216-295-91	SHORT	0
R206	1-216-033-00	RES,CHIP	220 5% 1/10W	R270	1-216-022-00	RES,CHIP	75 5% 1/10W
R208	1-216-041-00	RES,CHIP	470 5% 1/10W	R271	1-216-022-00	RES,CHIP	75 5% 1/10W
R209	1-216-182-00	RES,CHIP	220 5% 1/8W	R272	1-216-022-00	RES,CHIP	75 5% 1/10W
R210	1-216-017-91	RES,CHIP	47 5% 1/10W	R273	1-216-022-00	RES,CHIP	75 5% 1/10W
R211	1-216-033-00	RES,CHIP	220 5% 1/10W	R274	1-216-295-91	SHORT	0
R212	1-216-022-00	RES,CHIP	75 5% 1/10W	R275	1-216-295-91	SHORT	0
R213	1-216-022-00	RES,CHIP	75 5% 1/10W	R276	1-216-295-91	SHORT	0
R214	1-216-025-91	RES,CHIP	100 5% 1/10W	R277	1-216-295-91	SHORT	0



REF. NO.	PART.NO	DESCRIPTION	REMARK	REF. NO.	PART.NO	DESCRIPTION	REMARK
R280	1-216-049-91	RES,CHIP	1K 5% 1/10W	R339	1-216-049-91	RES,CHIP	1K 5% 1/10W
R281	1-216-081-91	RES,CHIP	22K 5% 1/10W	R340	1-216-025-91	RES,CHIP	100 5% 1/10W
R282	1-216-089-91	RES,CHIP	47K 5% 1/10W	R341	1-216-025-91	RES,CHIP	100 5% 1/10W
R283	1-216-049-91	RES,CHIP	1K 5% 1/10W	R342	1-216-049-91	RES,CHIP	1K 5% 1/10W
R284	1-216-081-91	RES,CHIP	22K 5% 1/10W	R343	1-216-061-00	RES,CHIP	3.3K 5% 1/10W
R285	1-216-089-91	RES,CHIP	47K 5% 1/10W	R344	1-216-067-00	RES,CHIP	5.6K 5% 1/10W
R286	1-216-049-91	RES,CHIP	1K 5% 1/10W	R345	1-216-025-91	RES,CHIP	100 5% 1/10W
R287	1-216-025-91	RES,CHIP	100 5% 1/10W	R346	1-216-065-91	RES,CHIP	4.7K 5% 1/10W
R291	1-216-049-91	RES,CHIP	1K 5% 1/10W	R347	1-216-025-91	RES,CHIP	100 5% 1/10W
R292	1-216-049-91	RES,CHIP	1K 5% 1/10W	R348	1-216-025-91	RES,CHIP	100 5% 1/10W
R293	1-216-049-91	RES,CHIP	1K 5% 1/10W	R349	1-216-025-91	RES,CHIP	100 5% 1/10W
R294	1-216-049-91	RES,CHIP	1K 5% 1/10W	R350	1-216-042-00	RES,CHIP	510 5% 1/10W
R295	1-216-049-91	RES,CHIP	1K 5% 1/10W	R351	1-216-053-00	RES,CHIP	1.5K 5% 1/10W
R296	1-216-049-91	RES,CHIP	1K 5% 1/10W	R352	1-216-077-00	RES,CHIP	15K 5% 1/10W
R297	1-216-022-00	RES,CHIP	75 5% 1/10W	R353	1-216-033-00	RES,CHIP	220 5% 1/10W
R300	1-216-025-91	RES,CHIP	100 5% 1/10W	R354	1-216-295-91	SHORT	0
R301	1-216-033-00	RES,CHIP	220 5% 1/10W	R357	1-216-049-91	RES,CHIP	1K 5% 1/10W
R302	1-216-295-91	SHORT	0	R358	1-216-295-91	SHORT	0
R303	1-216-295-91	SHORT	0	R359	1-216-097-91	RES,CHIP	100K 5% 1/10W
R308	1-216-025-91	RES,CHIP	100 5% 1/10W	R360	1-216-049-91	RES,CHIP	1K 5% 1/10W
R309	1-216-033-00	RES,CHIP	220 5% 1/10W	R362	1-216-049-91	RES,CHIP	1K 5% 1/10W
R310	1-216-033-00	RES,CHIP	220 5% 1/10W	R364	1-216-049-91	RES,CHIP	1K 5% 1/10W
R311	1-216-295-91	SHORT	0	R370	1-216-295-91	SHORT	0
R312	1-216-295-91	SHORT	0	R401	1-216-033-00	RES,CHIP	220 5% 1/10W
R314	1-216-295-91	SHORT	0	R402	1-216-049-91	RES,CHIP	1K 5% 1/10W
R315	1-216-295-91	SHORT	0	R403	1-216-065-91	RES,CHIP	4.7K 5% 1/10W
R316	1-216-033-00	RES,CHIP	220 5% 1/10W	R404	1-216-083-00	RES,CHIP	27K 5% 1/10W
R318	1-216-089-91	RES,CHIP	47K 5% 1/10W	R405	1-216-073-00	RES,CHIP	10K 5% 1/10W
R319	1-216-081-00	RES,CHIP	22K 5% 1/10W	R406	1-216-073-00	RES,CHIP	10K 5% 1/10W
R320	1-216-025-91	RES,CHIP	100 5% 1/10W	R407	1-216-073-00	RES,CHIP	10K 5% 1/10W
R321	1-216-025-91	RES,CHIP	100 5% 1/10W	R408	1-216-049-91	RES,CHIP	1K 5% 1/10W
R322	1-216-025-91	RES,CHIP	100 5% 1/10W	R409	1-216-049-91	RES,CHIP	1K 5% 1/10W
R323	1-216-033-00	RES,CHIP	220 5% 1/10W	R410	1-216-049-91	RES,CHIP	1K 5% 1/10W
R324	1-216-065-91	RES,CHIP	4.7K 5% 1/10W	R411	1-216-065-91	RES,CHIP	4.7K 5% 1/10W
R326	1-216-025-91	RES,CHIP	100 5% 1/10W	R1001	1-216-025-91	RES,CHIP	100 5% 1/10W
R327	1-216-025-91	RES,CHIP	100 5% 1/10W	R1002	1-216-025-91	RES,CHIP	100 5% 1/10W
R328	1-216-129-00	RES,CHIP	2.2M 5% 1/10W	R1005	1-216-041-00	RES,CHIP	470 5% 1/10W
R329	1-216-083-00	RES,CHIP	27K 5% 1/10W	R1006	1-216-049-91	RES,CHIP	1K 5% 1/10W
R330	1-216-025-91	RES,CHIP	100 5% 1/10W	R1007	1-216-073-91	RES,CHIP	10K 5% 1/10W
R331	1-216-057-00	RES,CHIP	2.2K 5% 1/10W	R1010	1-216-295-91	SHORT	0
R332	1-216-025-91	RES,CHIP	100 5% 1/10W	R1012	1-216-041-00	RES,CHIP	470 5% 1/10W
R333	1-216-075-00	RES,CHIP	12K 5% 1/10W	R1014	1-216-065-91	RES,CHIP	4.7K 5% 1/10W
R334	1-216-041-00	RES,CHIP	470 5% 1/10W	R1015	1-216-041-91	RES,CHIP	470 5% 1/10W
R335	1-216-675-11	METAL CHIP	10K 0.50% 1/10W	R1016	1-216-073-91	RES,CHIP	10K 5% 1/10W
R336	1-216-109-00	RES,CHIP	330K 5% 1/10W	R1017	1-216-295-91	SHORT	0
R337	1-216-025-91	RES,CHIP	100 5% 1/10W	R1021	1-216-025-91	RES,CHIP	100 5% 1/10W
R338	1-216-051-00	RES,CHIP	1.2K 5% 1/10W	R1022	1-216-025-91	RES,CHIP	100 5% 1/10W



REF.NO. PART.NO DESCRIPTION REMARK

R1023 1-216-025-91 RES,CHIP 100 5% 1/10W
 R1024 1-216-041-00 RES,CHIP 470 5% 1/10W
 R1026 1-216-025-91 RES,CHIP 100 5% 1/10W
 R1027 1-216-025-91 RES,CHIP 100 5% 1/10W
 R1028 1-216-025-91 RES,CHIP 100 5% 1/10W

< CRYSTAL >

X1 1-767-154-21 VIBRATOR, CERAMIC
 X201 1-760-628-11 VIBRATOR, CRYSTAL
 X301 1-567-504-11 OSCILLATOR, CRYSTAL
 X302 1-567-505-11 OSCILLATOR, CRYSTAL
 X303 1-767-127-11 VIBRATOR, CERAMIC
 X1001 1-579-965-21 VIBRATOR, CRYSTAL

A Board Variant Parts

**KV-32FX20A/32FX20B/32FX20D/
 KV-32FX20E**

< FILTER >

CF120 1-409-327-00 TRAP, CERAMIC (6.5MHZ)

< IC >

IC202 8-759-584-22 IC MSP3400D-PS-B4-T (KV-32FX20A/32FX20D)
 8-759-491-94 IC MSP3410D-PS-B4-T (KV-32FX20B/32FX20E)
 IC303 8-759-430-79 IC TDA8395T/N3 (KV-32FX20B/32FX20D/32FX20E)

< COIL >

L102 1-409-600-21 INDUCTOR 5.6UH

< TRANSISTOR >

Q121 8-729-120-28 TRANSISTOR 2SC1623-L5L6
 Q124 8-729-120-28 TRANSISTOR 2SC1623-L5L6
 Q130 8-729-026-49 TRANSISTOR 2SA1037AK

< TUNER >

TU101 1-693-338-11 TUNER/VIF (AEP) (KV-32FX20A/32FX20D/32FX20E)
 1-693-340-11 TUNER/VIF (FR) (KV-32FX20B)

A Board Variant Parts KV-32FX20U

< IC >

IC202 8-759-491-94 IC MSP3410D-PS-B4-T

< TUNER >

TU101 1-693-339-11 TUNER/VIF (UK)

REF.NO. PART.NO DESCRIPTION REMARK

***A-1638-126-A C Board, Complete**

< CAPACITOR >

C702 1-128-551-11 ELECT 22MF 20% 25V
 C703 1-104-664-11 ELECT 47MF 20% 10V
 C704 1-102-945-00 CERAMIC 8PF 0.5PF 50V
 C705 1-102-945-00 CERAMIC 8PF 0.5PF 50V
 C706 1-102-953-00 CERAMIC 18PF 5% 50V
 C707 1-107-651-11 ELECT 4.7MF 20% 250V
 C708 1-126-960-11 ELECT 1MF 20% 50V
 C709 1-101-006-00 CERAMIC 0.047MF 50V
 C710 1-107-651-11 ELECT 4.7MF 20% 250V
 C711 1-107-651-11 ELECT 4.7MF 20% 250V
 C712 1-101-006-00 CERAMIC 0.047MF 50V
 C714 1-101-006-00 CERAMIC 0.047MF 50V
 C715 1-101-006-00 CERAMIC 0.047MF 50V
 C716 1-102-157-00 CERAMIC 560PF 10% 500V
 C717 1-102-157-00 CERAMIC 560PF 10% 500V
 C718 1-102-157-00 CERAMIC 560PF 10% 500V
 C719 1-102-074-00 CERAMIC 0.001MF 10% 50V
 C725 1-107-651-11 ELECT 4.7MF 20% 250V
 C731 1-117-214-11 CERAMIC 0.001MF 10% 2KV

< CONNECTOR >

CN701 *1-568-882-51 PIN, CONNECTOR 7P
 CN703 1-778-037-11 PIN, CONNECTOR 6P
 CN705 1-695-915-11 TAB (CONTACT)
 CN706 1-695-915-11 TAB (CONTACT)
 CN708 1-695-915-11 TAB (CONTACT)

< DIODE >

D701 8-719-109-85 DIODE RD5.1ESB2
 D704 8-719-991-33 DIODE 1SS133T-77
 D705 8-719-991-33 DIODE 1SS133T-77
 D707 8-719-991-33 DIODE 1SS133T-77
 D709 8-719-051-85 DIODE HSS83TD
 D710 8-719-051-85 DIODE HSS83TD
 D711 8-719-051-85 DIODE HSS83TD
 D712 8-719-908-03 DIODE GP08D
 D713 8-719-109-72 DIODE RD3.9ESB2
 D714 8-719-991-33 DIODE 1SS133T-77

< IC >

IC701 8-759-346-42 IC TDA6101Q/N3
 IC702 8-759-346-42 IC TDA6101Q/N3
 IC703 8-759-346-42 IC TDA6101Q/N3

The components identified by shading and marked Δ are critical for safety
 Replace only with the part number specified.

C **D1**

REF. NO.	PART.NO	DESCRIPTION	REMARK	REF. NO.	PART.NO	DESCRIPTION	REMARK
< CRT SOCKET >				< SPARK GAP >			
J701	Δ 1-526-990-21	SOCKET, CRT		SG701	1-517-712-31	GAP, SPARK	
< COIL >				SG702	1-517-712-31	GAP, SPARK	
L701	1-410-667-31	INDUCTOR	22UH	SG703	1-517-712-31	GAP, SPARK	
< TRANSISTOR >				SG704	1-519-421-11	GAP, DISCHARGE	
Q701	8-729-119-76	TRANSISTOR 2SA1175-HFE		*A-1640-350-A D1 Board, Complete			
< RESISTOR >				4-382-854-11	SCREW (M3X10), P, SW (+)		
R701	1-247-807-31	CARBON	100 5% 1/4W	*4-931-401-01	HEAT SINK, V.OUT		
R702	1-249-417-11	CARBON	1K 5% 1/4W	< CAPACITOR >			
R703	1-249-437-11	CARBON	47K 5% 1/4W	C2201	1-102-121-00	CERAMIC	0.0022MF 10% 50V
R704	1-215-413-00	METAL	470 1% 1/4W	C2202	1-102-121-00	CERAMIC	0.0022MF 10% 50V
R705	1-249-441-11	CARBON	100K 5% 1/4W	C2203	1-126-964-11	ELECT	10MF 20% 50V
R706	1-535-465-11	LEAD, JUMPER (5.0MM)		C2204	1-126-964-11	ELECT	10MF 20% 50V
R707	1-215-424-00	METAL	1.3K 1% 1/4W	C2208	1-137-194-81	FILM	0.47MF 5% 50V
R708	1-215-424-00	METAL	1.3K 1% 1/4W	C2209	1-136-177-00	FILM	1MF 5% 50V
R709	1-215-424-00	METAL	1.3K 1% 1/4W	C2210	1-136-177-00	FILM	1MF 5% 50V
R710	1-215-413-00	METAL	470 1% 1/4W	C2211	1-137-194-81	FILM	0.47MF 5% 50V
R711	1-249-421-11	CARBON	2.2K 5% 1/4W	C2212	1-102-074-00	CERAMIC	0.001MF 10% 50V
R712	1-249-431-11	CARBON	15K 5% 1/4W	C2213	1-136-202-11	FILM	0.33MF 5% 63V
R718	1-249-422-11	CARBON	2.7K 5% 1/4W	C2214	1-102-114-00	CERAMIC	470PF 10% 50V
R719	1-249-422-11	CARBON	2.7K 5% 1/4W	C2215	1-130-777-00	FILM	0.1MF 5% 63V
R720	1-249-422-11	CARBON	2.7K 5% 1/4W	C2216	1-102-125-00	CERAMIC	0.0047MF 10% 50V
R722	1-249-435-11	CARBON	33K 5% 1/4W	C2217	1-102-106-00	CERAMIC	100PF 10% 50V
R725	1-215-903-11	METAL OXIDE	68K 5% 2W F	C2218	1-130-777-00	FILM	0.1MF 5% 63V
R727	1-215-903-11	METAL OXIDE	68K 5% 2W F	C2219	1-126-963-91	ELECT	4.7MF 20% 50V
R729	1-215-903-11	METAL OXIDE	68K 5% 2W F	C2220	1-130-777-00	FILM	0.1MF 5% 63V
R731	1-202-818-00	SOLID	1K 20% 1/2W	C2221	1-130-777-00	FILM	0.1MF 5% 63V
R732	1-202-818-00	SOLID	1K 20% 1/2W	C2222	1-130-777-00	FILM	0.1MF 5% 63V
R733	1-202-818-00	SOLID	1K 20% 1/2W	C2223	1-126-943-11	ELECT	2200MF 20% 25V
R734	1-247-739-11	CARBON	100 5% 1/2W	C2224	1-126-943-11	ELECT	2200MF 20% 25V
R738	1-249-489-11	CARBON	22K 5% 1/2W	C2501	1-104-665-11	ELECT	100MF 20% 25V
R740	1-216-391-11	METAL OXIDE	1.5 5% 3W F	C2502	1-126-933-11	ELECT	100MF 20% 16V
R742	1-215-912-11	METAL OXIDE	150 5% 3W F	C2503	1-102-228-00	CERAMIC	470PF 10% 500V
R743	1-202-847-00	SOLID	560K 20% 1/2W	C2504	1-126-941-11	ELECT	470MF 20% 25V
< VARIABLE RESISTOR >				C2801	1-102-244-00	CERAMIC	220PF 10% 500V
RV701	1-241-656-21	RES, ADJ, METAL FILM 110M		C2805	1-102-973-00	CERAMIC	100PF 5% 50V
				C2806	1-136-347-11	FILM	0.0047MF 5% 630V
				C2808	1-130-491-00	MYLAR	0.047MF 5% 50V
				C2809	1-130-483-00	MYLAR	0.01MF 5% 50V
				C2811	1-129-716-00	FILM	0.015MF 5% 630V
				C2813	1-102-228-00	CERAMIC	470PF 10% 500V
				C2814	1-129-992-00	FILM	0.0024MF 5% 630V
				C2815	1-117-455-11	FILM	22000PF 5% 630V
				C2817	1-126-933-11	ELECT	100MF 20% 16V

REF. NO.	PART.NO	DESCRIPTION	REMARK	REF. NO.	PART.NO	DESCRIPTION	REMARK
R2215	1-247-841-91	CARBON	2.7K 5% 1/4W	R2860	1-215-886-11	METAL OXIDE 100 5% 2W F	
R2216	1-247-865-91	CARBON	27K 5% 1/4W	R2861	1-215-886-11	METAL OXIDE 100 5% 2W F	
R2501	1-249-443-11	CARBON	0.47 5% 1/4W F	R3801	1-249-421-11	CARBON 2.2K 5% 1/4W	
R2801	1-535-465-11	LEAD, JUMPER (5.0MM)		R3804	1-249-421-11	CARBON 2.2K 5% 1/4W	
R2802	1-215-919-11	METAL OXIDE	2.2K 5% 3W F			< RELAY >	
R2804	1-249-437-11	CARBON	47K 5% 1/4W	RY3801	1-755-172-11	RELAY	
R2805	1-249-429-11	CARBON	10K 5% 1/4W	RY3802	1-755-172-11	RELAY	
R2811	1-215-445-00	METAL	10K 1% 1/4W			< TRANSFORMER >	
R2813	1-215-469-00	METAL	100K 1% 1/4W	T2801	1-433-849-11	TRANSFORMER, FERRITE (DFT)	
R2814	1-215-445-00	METAL	10K 1% 1/4W	T3801	1-419-090-11	COIL, CHOKE (100UH)	
R2815	1-215-469-00	METAL	100K 1% 1/4W	T3802	1-419-090-11	COIL, CHOKE (100UH)	
R2816	1-215-443-00	METAL	8.2K 1% 1/4W			*A-1642-251-A D2 Board, Complete	
R2817	1-215-463-00	METAL	56K 1% 1/4W			4-382-854-11	SCREW (M3X10), P, SW (+)
R2818	1-215-459-00	METAL	39K 1% 1/4W			< CAPACITOR >	
R2819	1-249-421-11	CARBON	2.2K 5% 1/4W	C8801	1-107-683-11	ELECT 2.2MF 0 250V	
R2820	1-249-421-11	CARBON	2.2K 5% 1/4W	C8804	1-136-207-11	FILM 0.047MF 10% 250V	
R2821	1-247-807-31	CARBON	100 5% 1/4W	C8805	1-136-105-11	FILM 0.33MF 5% 200V	
R2823	1-535-465-11	LEAD, JUMPER (5.0MM)				< CONNECTOR >	
R2824	1-249-425-11	CARBON	4.7K 5% 1/4W	CN8801	*1-770-748-11	CONNECTOR, BOARD TO BOARD 12P	
R2825	1-249-417-11	CARBON	1K 5% 1/4W			< DIODE >	
R2826	1-249-417-11	CARBON	1K 5% 1/4W	D8801	8-719-923-60	DIODE MTZJ-T-77-9.1A	
R2827	1-249-441-11	CARBON	100K 5% 1/4W	D8802	8-719-302-43	DIODE EL1Z	
R2828	1-249-441-11	CARBON	100K 5% 1/4W			< IC >	
R2829	1-249-441-11	CARBON	100K 5% 1/4W	IC8801	8-749-010-64	PHOTO COUPLER PC123F2	
R2830	1-215-912-11	METAL OXIDE	150 5% 3W F			< COIL >	
R2831	1-215-912-11	METAL OXIDE	150 5% 3W F	L8801	1-406-674-11	INDUCTOR 3.3MMH	
R2832	1-249-379-11	CARBON	0.68 5% 1/4W F	L8802	1-406-978-11	INDUCTOR 150UH	
R2840	1-215-922-11	METAL OXIDE	6.8K 5% 3W F			< TRANSISTOR >	
R2841	1-215-922-11	METAL OXIDE	6.8K 5% 3W F	Q8802	8-729-030-02	TRANSISTOR DTC144ESA	
R2842	1-215-921-21	METAL OXIDE	4.7K 5% 3W F	Q8803	8-729-030-02	TRANSISTOR DTC144ESA	
R2843	1-215-921-21	METAL OXIDE	4.7K 5% 3W F			< RESISTOR >	
R2844	1-249-409-11	CARBON	220 5% 1/4W F	R8801	1-215-909-11	METAL OXIDE 47 5% 3W F	
R2845	1-215-489-00	METAL	680K 1% 1/4W	R8802	1-249-441-11	CARBON 100K 5% 1/4W	
R2846	1-247-903-00	CARBON	1M 5% 1/4W	R8803	1-249-441-11	CARBON 100K 5% 1/4W	
R2847	1-249-429-11	CARBON	10K 5% 1/4W	R8804	1-249-421-11	CARBON 2.2K 5% 1/4W	
R2848	1-215-449-00	METAL	15K 1% 1/4W	R8805	1-249-429-11	CARBON 10K 5% 1/4W	
R2849	1-215-491-00	METAL	820K 1% 1/4W				
R2850	1-215-445-00	METAL	10K 1% 1/4W				
R2851	1-215-445-00	METAL	10K 1% 1/4W				
R2852	1-215-481-00	METAL	330K 1% 1/4W				
R2853	1-215-477-00	METAL	220K 1% 1/4W				
R2854	1-215-457-00	METAL	33K 1% 1/4W				
R2855	1-215-457-00	METAL	33K 1% 1/4W				
R2856	1-247-807-31	CARBON	100 5% 1/4W				
R2857	1-249-413-11	CARBON	470 5% 1/4W				
R2858	1-249-424-11	CARBON	3.9K 5% 1/4W				
R2859	1-247-807-31	CARBON	100 5% 1/4W				



The components identified by shading and marked Δ are critical for safety
 Replace only with the part number specified.

REF. NO.	PART. NO	DESCRIPTION	REMARK
R8806	1-247-807-31	CARBON 100 5%	1/4W
R8807	1-202-885-91	RES, SOLID 1M 20%	1/2W
*A-1642-252-A D Board, Complete			
	4-201-023-01	SPACER, INSULATING	
	4-202-373-01	SPRING, IC	
	4-202-710-01	SPACER, INSULATING	
	4-382-854-11	SCREW (M3X10), P, SW (+)	
< CAPACITOR >			
C502	1-102-119-00	CERAMIC 0.0015MF 10%	50V
C503	1-136-165-00	FILM 0.1MF 5%	50V
C504	1-102-119-00	CERAMIC 0.0015MF 10%	50V
C506	1-126-941-11	ELECT 470MF 20%	25V
C507	1-109-953-11	ELECT 2.2MF 20%	50V
C509	1-136-165-00	FILM 0.1MF 5%	50V
C510	1-126-969-11	ELECT 220MF 20%	50V
C511	1-136-202-11	FILM 0.33MF 5%	63V
C513	1-106-220-00	MYLAR 0.1MF 10%	100V
C514	1-136-165-00	FILM 0.1MF 5%	50V
C515	1-126-941-11	ELECT 470MF 20%	25V
C517	1-126-941-11	ELECT 470MF 20%	25V
C518	1-102-228-00	CERAMIC 470PF 10%	500V
C519	1-102-228-00	CERAMIC 470PF 10%	500V
C520	1-126-941-11	ELECT 470MF 20%	25V
C521	1-107-698-11	ELECT 10MF 20%	25V
C522	1-126-964-11	ELECT 10MF 20%	50V
C523	1-136-165-00	FILM 0.1MF 5%	50V
C600	Δ 1-119-888-51	CERAMIC 0.0022MF 20%	250V
C601	Δ 1-161-964-91	CERAMIC 0.0047MF	250V
C602	Δ 1-161-964-91	CERAMIC 0.0047MF	250V
C603	1-117-752-11	ELECT (BLOCK) 330MF 20%	450V
C604	1-126-968-11	ELECT 100MF 20%	50V
C605	1-107-929-11	ELECT 10MF 20%	100V
C606	1-162-318-11	CERAMIC 0.001MF 10%	500V
C607	1-104-666-11	ELECT 220MF 20%	25V
C608	1-109-880-11	FILM 0.0015MF 3%	2KV
C611	1-102-228-00	CERAMIC 470PF 10%	500V
C613	1-124-347-00	ELECT 100MF 20%	160V
C614	1-126-933-11	ELECT 100MF 20%	16V
C615	1-115-789-11	ELECT 0.001F 20%	25V
C616	1-115-789-11	ELECT 0.001F 20%	25V
C618	1-136-165-00	FILM 0.1MF 5%	50V
C619	1-102-228-00	CERAMIC 470PF 10%	500V
C620	1-102-228-00	CERAMIC 470PF 10%	500V
C622	1-107-925-11	ELECT 1MF 20%	100V
C624	1-136-165-00	FILM 0.1MF 5%	50V

REF. NO.	PART. NO	DESCRIPTION	REMARK
C625	1-126-967-11	ELECT 47MF 20%	50V
C626	1-104-666-11	ELECT 220MF 20%	25V
C628	1-126-964-11	ELECT 10MF 20%	50V
C629	1-115-819-11	ELECT 0.0022F 20%	35V
C630	1-115-819-11	ELECT 0.0022F 20%	35V
C631	1-126-965-11	ELECT 22MF 20%	50V
C632	1-104-666-11	ELECT 220MF 20%	25V
C636	Δ 1-119-888-51	CERAMIC 0.0022MF 20%	250V
C638	1-136-203-11	FILM 0.01MF 10%	250V
C640	1-106-220-00	MYLAR 0.1MF 10%	100V
C641	Δ 1-113-916-11	CERAMIC 0.01MF 20%	250V
C642	Δ 1-113-916-11	CERAMIC 0.01MF 20%	250V
C647	1-162-116-00	CERAMIC 680PF 10%	2KV
C651	1-102-228-00	CERAMIC 470PF 10%	500V
C800	1-137-368-11	FILM 0.0047MF 5%	50V
C801	1-137-372-11	FILM 0.022MF 5%	50V
C802	1-102-117-91	CERAMIC 820PF 10%	50V
C803	1-129-898-00	FILM 0.0022MF 5%	630V
C804	1-136-165-00	FILM 0.1MF 5%	50V
C805	1-136-207-11	FILM 0.047MF 10%	250V
C806	1-107-370-11	FILM 0.1MF 10%	200V
C807	1-136-540-11	FILM 0.82MF 5%	200V
C811	1-162-318-11	CERAMIC 0.001MF 10%	500V
C812	1-136-540-11	FILM 0.82MF 5%	200V
C813	1-129-724-00	FILM 0.068MF 5%	630V
C814	1-136-952-11	FILM 0.02MF 3%	1.4KV
C815	1-137-046-11	FILM 0.0082MF 10%	400V
C816	1-117-214-11	CERAMIC 0.001MF 10%	2KV
C817	1-117-214-11	CERAMIC 0.001MF 10%	2KV
C818	1-117-214-11	CERAMIC 0.001MF 10%	2KV
C819	1-136-208-11	FILM 0.068MF 10%	250V
C822	1-107-662-11	ELECT 22MF 20%	250V
C824	1-123-024-21	ELECT 33MF	160V
C826	1-161-830-00	CERAMIC 0.0047MF	500V
C829	1-126-959-11	ELECT 0.47MF 20%	50V
C832	1-126-960-91	ELECT 1MF 20%	25V
C834	1-128-551-11	ELECT 22MF 20%	25V
C835	1-162-318-11	CERAMIC 0.001MF 10%	500V
C836	1-162-117-00	CERAMIC 100PF 10%	500V
C838	1-102-228-00	CERAMIC 470PF 10%	500V
C839	1-136-207-11	FILM 0.047MF 10%	250V
C841	1-102-114-00	CERAMIC 470PF 10%	50V
C845	1-101-880-00	CERAMIC 47PF 5%	50V
C910	1-535-465-11	LEAD, JUMPER (5.0MM)	
C916	1-162-318-11	CERAMIC 0.001MF 10%	500V
C1200	1-136-165-00	FILM 0.1MF 5%	50V
C1201	1-137-194-81	FILM 0.47MF 5%	50V

The components identified by shading and marked Δ are critical for safety. Replace only with the part number specified.

D

REF. NO.	PART.NO	DESCRIPTION	REMARK	REF. NO.	PART.NO	DESCRIPTION	REMARK
C1202	1-137-194-81	FILM	0.47MF 5% 50V	D504	8-719-991-33	DIODE 1SS133T-77	
C1203	1-136-169-00	FILM	0.22MF 5% 50V	D505	8-719-982-03	DIODE MTZJ-3.6A	
C1204	1-136-169-00	FILM	0.22MF 5% 50V	D506	8-719-991-33	DIODE 1SS133T-77	
C1205	1-101-005-00	CERAMIC	0.022MF 50V	D507	8-719-109-85	DIODE RD5.1ESB2	
C1206	1-101-005-00	CERAMIC	0.022MF 50V	D510	8-719-924-13	DIODE MTZJ-T-77-22B	
C1207	1-126-933-11	ELECT	100MF 20% 16V	D570	8-719-924-13	DIODE MTZJ-T-77-22B	
C1208	1-126-963-11	ELECT	4.7MF 20% 50V	D571	8-719-924-13	DIODE MTZJ-T-77-22B	
C1209	1-126-963-11	ELECT	4.7MF 20% 50V	D600	8-719-510-53	DIODE D4SB60L	
C1210	1-126-941-11	ELECT	470MF 20% 25V	D601	8-719-046-77	DIODE EMI-V1	
C1212	1-162-318-11	CERAMIC	0.001MF 10% 500V	D603	8-719-109-97	DIODE RD6.8ESB2	
C1213	1-162-318-11	CERAMIC	0.001MF 10% 500V	D604	8-719-046-75	DIODE EU-1-V1	
C1214	1-126-933-11	ELECT	100MF 20% 16V	D605	8-719-302-43	DIODE EL1Z	
C1215	1-137-194-81	FILM	0.47MF 5% 50V	D606	8-719-302-43	DIODE EL1Z	
C1216	1-137-366-11	FILM	0.0022MF 5% 50V	D607	8-719-046-78	DIODE EG-1Z-V1	
C1217	1-137-366-11	FILM	0.0022MF 5% 50V	D608	8-719-302-06	DIODE EU2A	
C1218	1-126-941-11	ELECT	470MF 20% 25V	D609	8-719-053-32	DIODE FMU-G16S	
C1220	1-162-318-11	CERAMIC	0.001MF 10% 500V	D611	8-719-058-38	DIODE FMN-G12S	
C1221	1-162-318-11	CERAMIC	0.001MF 10% 500V	D612	8-719-058-38	DIODE FMN-G12S	
C1223	1-101-006-00	CERAMIC	0.047MF 50V	D613	8-719-058-38	DIODE FMN-G12S	
		< CONNECTOR >		D614	8-719-058-38	DIODE FMN-G12S	
CN600	Δ *1-508-786-00	PIN, CONNECTOR (5MM PITCH) 2P		D617	8-719-991-33	DIODE 1SS133T-77	
CN601	Δ 1-508-765-00	PIN, CONNECTOR (5MM PITCH) 3P		D618	8-719-991-33	DIODE 1SS133T-77	
CN602	Δ *1-691-291-11	PIN, CONNECTOR (PC BOARD) 5P		D619	8-719-991-33	DIODE 1SS133T-77	
CN613	4-352-844-01	PIN, LEAD, COATING		D620	8-719-991-33	DIODE 1SS133T-77	
CN614	1-695-915-11	TAB (CONTACT)		D622	8-719-923-60	DIODE MTZJ-T-77-9.1A	
CN615	1-695-915-11	TAB (CONTACT)		D625	8-719-991-33	DIODE 1SS133T-77	
CN616	4-352-844-01	PIN, LEAD, COATING		D637	8-719-110-17	DIODE RD10ESB2	
CN800	*1-580-798-11	CONNECTOR PIN (DY) 6P		D638	8-719-991-33	DIODE 1SS133T-77	
CN801	*1-568-879-11	PIN, CONNECTOR 4P		D800	8-719-991-33	DIODE 1SS133T-77	
CN802	1-695-915-11	TAB (CONTACT)		D801	8-719-991-33	DIODE 1SS133T-77	
CN803	1-695-915-11	TAB (CONTACT)		D802	1-535-465-11	LEAD, JUMPER (5.0MM)	
CN804	1-778-037-11	PIN, CONNECTOR 6P		D803	8-719-908-03	DIODE GP08D	
CN805	*1-770-747-11	CONNECTOR, BOARD TO BOARD 12P		D807	8-719-302-43	DIODE EL1Z	
CN901	*1-568-882-51	PIN, CONNECTOR 7P		D808	8-719-908-03	DIODE GP08D	
CN902	1-695-299-11	CONNECTOR, BOARD TO BOARD 50P		D810	8-719-302-43	DIODE EL1Z	
CN903	*1-564-516-11	PLUG, CONNECTOR 13P		D811	8-719-110-41	DIODE RD15ESB2	
CN904	*1-564-511-11	PLUG, CONNECTOR 8P		D812	8-719-038-49	DIODE FMS-3FU-LF027-103	
CN1401	*1-568-880-51	PIN, CONNECTOR 5P		D815	8-719-908-03	DIODE GP08D	
CN1403	*1-564-511-11	PLUG, CONNECTOR 8P		D817	8-719-109-85	DIODE RD5.1ESB2	
CN1408	*1-568-879-11	PIN, CONNECTOR 4P		D902	8-719-923-60	DIODE MTZJ-T-77-9.1A	
CN1803	*1-564-508-11	PLUG, CONNECTOR 5P		D903	8-719-923-60	DIODE MTZJ-T-77-9.1A	
		< DIODE >		D904	8-719-923-60	DIODE MTZJ-T-77-9.1A	
D500	8-719-109-85	DIODE RD5.1ESB2		D905	8-719-923-60	DIODE MTZJ-T-77-9.1A	
D502	8-719-979-85	DIODE EGP20G		D906	8-719-923-60	DIODE MTZJ-T-77-9.1A	
D503	8-719-979-85	DIODE EGP20G		D920	8-719-109-89	DIODE RD5.6ESB2	
				D1201	8-719-109-72	DIODE RD3.9ESB2	

D

The components identified by shading and marked Δ are critical for safety
 Replace only with the part number specified.

REF. NO.	PART.NO	DESCRIPTION	REMARK	REF. NO.	PART.NO	DESCRIPTION	REMARK
< FERRITE BEAD >							
FB501	1-410-397-21	FERRITE	1.1UH	L803	1-535-465-11	LEAD, JUMPER (5.0MM)	
FB600	1-410-396-41	FERRITE	0.45UH	L806	1-535-465-11	LEAD, JUMPER (5.0MM)	
FB601	1-410-396-41	FERRITE	0.45UH	L809	1-408-611-31	INDUCTOR 47UH	
FB602	1-410-397-21	FERRITE	1.1UH	L813	1-412-552-11	INDUCTOR 2.2MMH	
FB603	1-410-396-41	FERRITE	0.45UH	< IC LINK >			
FB604	1-410-396-41	FERRITE	0.45UH	PS600	Δ 1-532-686-21	LINK, IC 2.7A (ICP-F75)	
FB605	1-410-396-41	FERRITE	0.45UH	PS601	Δ 1-532-686-21	LINK, IC 2.7A (ICP-F75)	
FB606	1-410-397-21	FERRITE	1.1UH	PS602	Δ 1-532-686-21	LINK, IC 2.7A (ICP-F75)	
FB607	1-410-397-21	FERRITE	1.1UH	PS603	Δ 1-532-686-21	LINK, IC 2.7A (ICP-F75)	
FB608	1-410-396-41	FERRITE	0.45UH	< TRANSISTOR >			
FB800	1-410-397-21	FERRITE	1.1UH	Q501	8-729-119-78	TRANSISTOR 2SC2785-HFE	
FB801	1-410-396-41	FERRITE	0.45UH	Q502	8-729-119-76	TRANSISTOR 2SA1175-HFE	
FB901	1-535-465-41	LEAD, JUMPER (5.0MM)		Q503	8-729-030-02	TRANSISTOR DTC144ESA	
FB902	1-535-465-41	LEAD, JUMPER (5.0MM)		Q601	8-729-025-04	TRANSISTOR 2SC3852A	
< ENCAPSULATED FILTER >				Q605	8-729-119-78	TRANSISTOR 2SC2785-HFE	
FL501	1-236-163-41	ENCAPSULATED COMPONENT		Q606	8-729-029-56	TRANSISTOR DTA144ESA	
< IC >				Q607	8-729-119-78	TRANSISTOR 2SC2785-HFE	
IC500	8-759-192-71	IC STV9379		Q611	8-729-200-21	TRANSISTOR 2SC2500-B	
IC600	8-749-010-92	IC STR-S6709		Q801	8-729-039-68	TRANSISTOR IRF620	
IC601	Δ 8-749-013-21	IC TLP721 (D4-G)		Q802	8-729-042-86	TRANSISTOR 2SC5251-01	
IC602	8-749-016-19	IC SE135N-LF4		Q803	8-729-119-80	TRANSISTOR 2SC2688-LK	
IC603	8-759-144-82	IC UPC2405HF		Q805	8-729-030-02	TRANSISTOR DTC144ESA	
IC606	8-759-267-25	IC LM2940T-9.0		Q900	8-729-119-78	TRANSISTOR 2SC2785-HFE	
IC800	8-759-103-93	IC UPC393C		Q1200	8-729-119-78	TRANSISTOR 2SC2785-HFE	
IC1200	8-759-585-29	IC TDA7264A		Q1201	8-729-029-94	TRANSISTOR DTC143TSA	
IC1201	8-759-502-21	IC TDA2822M		Q1202	8-729-029-66	TRANSISTOR DTC114ESA	
< SOCKET >				Q1203	8-729-029-94	TRANSISTOR DTC143TSA	
J1200	1-770-218-11	JACK, PIN		Q1204	8-729-029-94	TRANSISTOR DTC143TSA	
< COIL >				< RESISTOR >			
L501	1-535-465-11	LEAD, JUMPER (5.0MM)		JW010	1-410-397-21	FERRITE 1.1UH	
L502	1-412-519-11	INDUCTOR 3.3UH		JW125	1-247-841-91	CARBON 2.7K 5% 1/4W	
L503	1-412-519-11	INDUCTOR 3.3UH		R500	1-215-457-00	METAL 33K 1% 1/4W	
L609	1-412-533-21	INDUCTOR 47UH		R502	1-249-421-11	CARBON 2.2K 5% 1/4W	
L610	1-535-465-11	LEAD, JUMPER (5.0MM)		R503	1-249-429-11	CARBON 10K 5% 1/4W	
L611	1-412-527-11	INDUCTOR 15UH		R504	1-215-447-00	METAL 12K 1% 1/4W	
L612	1-412-522-41	INDUCTOR 5.6UH		R505	1-249-382-11	CARBON 1.2 5% 1/4W F	
L613	1-412-522-41	INDUCTOR 5.6UH		R506	1-215-455-00	METAL 27K 1% 1/4W	
L615	1-412-529-11	INDUCTOR 22UH		R507	1-215-888-00	METAL OXIDE 220 5% 2W F	
L616	1-412-533-21	INDUCTOR 47UH		R508	1-216-371-00	METAL OXIDE 1.5 5% 2W F	
L801	1-459-111-00	INDUCTOR 10MMH		R509	1-249-443-11	CARBON 0.47 5% 1/4W F	
L802	1-459-104-00	COIL, WITH CORE		R510	1-249-443-11	CARBON 0.47 5% 1/4W F	
				R519	1-215-451-00	METAL 18K 1% 1/4W	
				R520	1-215-451-00	METAL 18K 1% 1/4W	
				R521	1-215-459-00	METAL 39K 1% 1/4W	

The components identified by shading and marked Δ are critical for safety
 Replace only with the part number specified.

D

REF. NO.	PART.NO	DESCRIPTION	REMARK	REF. NO.	PART.NO	DESCRIPTION	REMARK
R522	1-247-863-91	CARBON	22K 5% 1/4W	R650	1-249-429-11	CARBON	10K 5% 1/4W
R523	1-247-863-91	CARBON	22K 5% 1/4W	R800	1-249-429-11	CARBON	10K 5% 1/4W
R524	1-249-425-11	CARBON	4.7K 5% 1/4W	R802	1-215-453-00	METAL	22K 1% 1/4W
R525	1-249-425-11	CARBON	4.7K 5% 1/4W	R803	1-249-427-11	CARBON	6.8K 5% 1/4W
R526	1-249-421-11	CARBON	2.2K 5% 1/4W	R805	1-249-435-11	CARBON	33K 5% 1/4W
R527	1-215-433-00	METAL	3.3K 1% 1/4W	R808	1-215-888-00	METAL OXIDE	220 5% 2W F
R540	1-249-441-11	CARBON	100K 5% 1/4W	R809	1-247-897-11	CARBON	560K 5% 1/4W
R600	Δ 1-216-490-11	METAL OXIDE	39K 5% 3W F	R810	1-215-888-00	METAL OXIDE	220 5% 2W F
R601	1-249-417-11	CARBON	1K 5% 1/4W	R812	1-249-421-11	CARBON	2.2K 5% 1/4W
R602	1-215-473-00	METAL	150K 1% 1/4W	R813	1-249-417-11	CARBON	1K 5% 1/4W F
R603	1-215-898-11	METAL OXIDE	10K 5% 2W F	R814	1-249-381-11	CARBON	1 5% 1/4W F
R604	1-249-420-11	CARBON	1.8K 5% 1/4W	R815	1-249-381-11	CARBON	1 5% 1/4W F
R605	1-216-362-11	METAL OXIDE	0.27 5% 2W F	R816	1-215-917-11	METAL OXIDE	1K 5% 3W F
R606	1-535-143-21	LEAD, JUMPER (12.5MM)		R818	1-215-884-11	METAL OXIDE	47 5% 2W F
R607	1-216-421-11	METAL OXIDE	12 5% 1W F	R819	1-535-143-71	LEAD, JUMPER (7.5MM)	
R608	1-216-365-00	METAL OXIDE	0.47 5% 2W F	R820	1-249-403-11	CARBON	68 5% 1/4W
R609	1-535-465-11	LEAD, JUMPER (5.0MM)		R822	1-215-868-00	METAL OXIDE	680 5% 1W F
R610	1-215-427-00	METAL	1.8K 1% 1/4W	R823	1-215-918-00	METAL OXIDE	1.5K 5% 3W F
R612	1-249-428-11	CARBON	8.2K 5% 1/4W	R824	1-249-420-11	CARBON	1.8K 5% 1/4W
R616	1-215-471-00	METAL	120K 1% 1/4W	R825	1-215-884-11	METAL OXIDE	47 5% 2W F
R617	1-215-901-00	METAL OXIDE	33K 5% 2W F	R826	1-260-099-11	CARBON	1K 5% 1/2W
R618	1-247-863-91	CARBON	22K 5% 1/4W	R827	1-249-425-11	CARBON	4.7K 5% 1/4W
R619	1-216-425-11	METAL OXIDE	56 5% 1W F	R828	1-249-432-11	CARBON	18K 5% 1/4W
R620	1-260-131-11	CARBON	470K 5% 1/2W	R829	1-260-120-11	CARBON	56K 5% 1/2W
R621	1-216-425-11	METAL OXIDE	56 5% 1W F	R831	1-535-465-11	LEAD, JUMPER (5.0MM)	
R622	1-249-437-11	CARBON	47K 5% 1/4W	R833	1-247-887-00	CARBON	220K 5% 1/4W
R623	1-249-429-11	CARBON	10K 5% 1/4W	R835	1-215-907-11	METAL OXIDE	22 5% 3W F
R624	1-249-393-11	CARBON	10 5% 1/4W F	R836	1-249-439-11	CARBON	68K 5% 1/4W
R625	1-249-434-11	CARBON	27K 5% 1/4W	R838	1-215-455-00	METAL	27K 1% 1/4W
R626	1-249-430-11	CARBON	12K 5% 1/4W	R840	1-247-807-31	CARBON	100 5% 1/4W
R627	1-216-347-11	METAL OXIDE	0.68 5% 1W F	R841	1-249-418-11	CARBON	1.2K 5% 1/4W
R628	1-249-415-11	CARBON	680 5% 1/4W F	R842	1-249-441-11	CARBON	100K 5% 1/4W
R631	Δ 1-202-968-11	CEMENTED	1.2 5% 10W	R844	1-535-143-11	LEAD, JUMPER (10.0MM)	
R632	1-247-807-31	CARBON	100 5% 1/4W	R846	1-259-883-11	CARBON	3.9M 5% 1/4W
R633	1-247-807-31	CARBON	100 5% 1/4W	R847	1-259-880-11	CARBON	2.2M 5% 1/4W
R634	1-249-397-11	CARBON	22 5% 1/4W F	R848	1-259-880-11	CARBON	2.2M 5% 1/4W
R636	1-249-417-11	CARBON	1K 5% 1/4W	R849	1-249-429-11	CARBON	10K 5% 1/4W
R637	1-247-815-91	CARBON	220 5% 1/4W	R851	1-215-898-11	METAL OXIDE	10K 5% 2W F
R638	1-247-863-91	CARBON	22K 5% 1/4W	R852	1-249-432-11	CARBON	18K 5% 1/4W
R639	1-215-425-00	METAL	1.5K 1% 1/4W	R853	1-216-361-00	METAL OXIDE	0.22 5% 2W F
R641	Δ 1-240-030-91	METAL	4.7M 5% 1/2W	R901	1-260-082-11	CARBON	39 5% 1/2W
R642	Δ 1-202-968-11	CEMENTED	1.2 5% 10W	R902	1-260-082-11	CARBON	39 5% 1/2W
R643	Δ 1-240-030-91	METAL	4.7M 5% 1/2W	R909	1-249-429-11	CARBON	10K 5% 1/4W
R646	1-249-377-11	CARBON	0.47 5% 1/4W F	R922	1-247-807-31	CARBON	100 5% 1/4W
R647	1-202-933-61	FUSIBLE	0.1 10% 1/2W F	R923	1-249-416-11	CARBON	820 5% 1/4W
R648	Δ 1-202-968-11	CEMENTED	1.2 5% 10W	R1200	1-249-425-11	CARBON	4.7K 5% 1/4W
R649	1-249-426-11	CARBON	5.6K 5% 1/4W	R1201	1-249-434-11	CARBON	27K 5% 1/4W



The components identified by shading and marked Δ are critical for safety
Replace only with the part number specified.

REF.NO.	PART.NO	DESCRIPTION	REMARK
R1202	1-249-389-11	CARBON	4.7 5% 1/4W F
R1203	1-249-417-11	CARBON	1K 5% 1/4W
R1204	1-249-417-11	CARBON	1K 5% 1/4W
R1205	1-249-428-11	CARBON	8.2K 5% 1/4W
R1206	1-249-428-11	CARBON	8.2K 5% 1/4W
R1207	1-249-413-11	CARBON	470 5% 1/4W
R1208	1-212-849-00	FUSIBLE	4.7 5% 1/4W F
R1209	1-212-849-00	FUSIBLE	4.7 5% 1/4W F
R1210	1-249-413-11	CARBON	470 5% 1/4W
R1211	1-249-424-11	CARBON	3.9K 5% 1/4W
R1212	1-249-424-11	CARBON	3.9K 5% 1/4W
R1213	1-249-421-11	CARBON	2.2K 5% 1/4W
R1216	1-249-413-11	CARBON	470 5% 1/4W
R1217	1-249-425-11	CARBON	4.7K 5% 1/4W
R1218	1-535-465-11	LEAD, JUMPER (5.0MM)	
R1219	1-249-417-11	CARBON	1K 5% 1/4W
R1220	1-247-863-91	CARBON	22K 5% 1/4W
R1221	1-247-863-91	CARBON	22K 5% 1/4W
< RELAY >			
RY600	Δ 1-755-018-11	RELAY	
RY601	Δ 1-755-266-11	RELAY, AC POWER	
< SWITCH >			
S801	1-572-707-11	SWITCH, LEVER	
< SPARK GAP >			
SG801	1-519-422-11	GAP, SPARK	
SG802	1-519-422-11	GAP, SPARK	
SG803	1-519-422-11	GAP, SPARK	
< TRANSFORMER >			
T601	Δ 1-429-604-11	TRANSFORMER, CONVERTER	
T800	1-426-981-11	TRANSFORMER, FERRITE (PMT)	
T803	Δ X-4560-158-1	TRANSFORMER ASSY, FLYBACK (NX-4404//U2B4)	
T804	1-437-195-14	TRANSFORMER, HORIZONTAL DRIVE	
T805	1-435-107-11	TRANSFORMER, HORIZONTAL LINEAR	
< THERMISTOR >			
THP600	Δ 1-809-827-11	THERMISTOR, POSITIVE	
*A-1644-098-A VM Board, Complete			
4-382-854-11	SCREW (M3X10), P, SW (+)		
< CAPACITOR >			
C1501	1-104-664-11	ELECT	47MF 20% 16V

REF.NO.	PART.NO	DESCRIPTION	REMARK
C1502	1-130-777-00	FILM	0.1MF 5% 63V
C1503	1-102-510-11	CERAMIC	12PF 5% 50V
C1504	1-136-177-00	FILM	1MF 5% 50V
C1505	1-136-177-00	FILM	1MF 5% 50V
C1506	1-102-973-00	CERAMIC	100PF 5% 50V
C1507	1-130-777-00	FILM	0.1MF 5% 63V
C1508	1-104-664-11	ELECT	47MF 20% 16V
C1509	1-136-202-11	FILM	0.33MF 5% 63V
C1510	1-102-980-00	CERAMIC	270PF 5% 50V
C1511	1-130-777-00	FILM	0.1MF 5% 63V
C1512	1-130-777-00	FILM	0.1MF 5% 63V
C1513	1-126-964-11	ELECT	10MF 20% 50V
C1514	1-126-967-11	ELECT	47MF 20% 50V
C1515	1-126-967-11	ELECT	47MF 20% 50V
C1516	1-102-852-91	CERAMIC	47PF 5% 50V
C1701	1-126-933-11	ELECT	100MF 20% 16V
C1702	1-126-933-11	ELECT	100MF 20% 16V
C1703	1-130-491-00	MYLAR	0.047MF 5% 50V
C1704	1-107-648-91	ELECT	100MF 20% 160V
C1705	1-107-638-11	ELECT	33MF 20% 160V
C1706	1-104-999-11	FILM	0.1MF 5% 200V
C1707	1-137-397-11	FILM	0.047MF 5% 100V
C1708	1-130-471-00	FILM	0.001MF 5% 50V
C1709	1-130-471-00	FILM	0.001MF 5% 50V
C1710	1-102-959-91	CERAMIC	22PF 5% 50V
C1711	1-126-962-11	ELECT	3.3MF 20% 50V
C1720	1-107-667-11	ELECT	2.2MF 20% 160V
C1721	1-137-397-11	FILM	0.047MF 5% 100V
C1722	1-126-935-11	ELECT	470MF 20% 16V
C1723	1-161-830-00	CERAMIC	0.0047MF 500V
C1725	1-128-551-11	ELECT	22MF 20% 25V
C1726	1-136-153-00	FILM	0.01MF 5% 50V
C1801	1-104-664-11	ELECT	47MF 20% 25V
C1803	1-137-368-11	FILM	0.0047MF 5% 50V
C1804	1-126-964-11	ELECT	10MF 20% 50V
C1805	1-137-366-11	FILM	0.0022MF 5% 50V
< CONNECTOR >			
CN1501	*1-564-506-11	PLUG, CONNECTOR 3P	
CN1502	*1-564-508-11	PLUG, CONNECTOR 5P	
CN1503	*1-564-506-11	PLUG, CONNECTOR 3P	
CN1716	*1-568-880-51	PIN, CONNECTOR 5P	
CN1717	*1-568-881-51	PIN, CONNECTOR 6P	
CN1718	*1-770-723-11	CONNECTOR, BOARD TO BOARD 8P	
CN1719	1-568-878-51	PIN, CONNECTOR 3P	
CN1801	*1-564-508-11	PLUG, CONNECTOR 5P	
CN1802	*1-568-878-51	PIN, CONNECTOR 3P	

The components identified by shading and marked Δ are critical for safety. Replace only with the part number specified.



REF. NO.	PART.NO	DESCRIPTION	REMARK	REF. NO.	PART.NO	DESCRIPTION	REMARK
< DIODE >				R1509	1-247-843-11	CARBON 3.3K 5%	1/4W
D1501	8-719-991-33	DIODE 1SS133T-77		R1510	1-249-421-11	CARBON 2.2K 5%	1/4W
D1502	8-719-991-33	DIODE 1SS133T-77		R1511	1-249-441-11	CARBON 100K 5%	1/4W
D1503	8-719-991-33	DIODE 1SS133T-77		R1512	1-249-417-11	CARBON 1K 5%	1/4W
D1504	8-719-991-33	DIODE 1SS133T-77		R1513	1-249-441-11	CARBON 100K 5%	1/4W
D1505	1-535-465-11	LEAD, JUMPER (5.0MM)		R1514	1-260-321-71	CARBON 270 5%	1/2W
D1506	8-719-911-19	DIODE 1SS119-25		R1515	1-249-417-11	CARBON 1K 5%	1/4W
D1701	8-719-991-33	DIODE 1SS133T-77		R1516	1-247-895-91	CARBON 470K 5%	1/4W
D1702	8-719-110-88	DIODE RD39ESB2		R1517	1-247-807-31	CARBON 100 5%	1/4W
D1703	8-719-110-88	DIODE RD39ESB2		R1518	1-247-807-31	CARBON 100 5%	1/4W
D1801	8-719-929-15	DIODE HZS9.1NB2		R1520	1-247-883-00	CARBON 150K 5%	1/4W
< IC >				R1521	1-249-429-11	CARBON 10K 5%	1/4W
IC1501	8-759-478-66	IC CXA8070P		R1522	1-249-421-11	CARBON 2.2K 5%	1/4W
IC1502	8-759-903-16	IC LM318P		R1523	1-249-429-11	CARBON 10K 5%	1/4W
IC1801	8-759-701-59	IC NJM78M09FA		R1525	1-215-453-00	METAL 22K 1%	1/4W
IC1802	8-759-603-37	IC M5216P		R1526	1-215-437-00	METAL 4.7K 1%	1/4W
< COIL >				R1527	1-215-437-00	METAL 4.7K 1%	1/4W
L1701	1-535-465-11	LEAD, JUMPER (5.0MM)		R1528	1-249-429-11	CARBON 10K 5%	1/4W
L1703	1-408-603-31	INDUCTOR 10UH		R1530	1-247-863-91	CARBON 22K 5%	1/4W
L1704	1-408-603-31	INDUCTOR 10UH		R1532	1-215-445-00	METAL 10K 1%	1/4W
< IC LINK >				R1534	1-247-807-31	CARBON 100 5%	1/4W
PS1801 Δ	1-532-605-00	LINK, IC 0.4A (ICPN10)		R1535	1-215-443-91	METAL 8.2K 1%	1/4W
< TRANSISTOR >				R1536	1-249-421-11	CARBON 2.2K 5%	1/4W
Q1501	8-729-119-78	TRANSISTOR 2SC2785-HFE		R1537	1-249-421-11	CARBON 2.2K 5%	1/4W
Q1502	8-729-119-78	TRANSISTOR 2SC2785-HFE		R1538	1-212-849-00	FUSIBLE 4.7 5%	1/4W F
Q1503	8-729-119-76	TRANSISTOR 2SA1175-HFE		R1539	1-212-849-00	FUSIBLE 4.7 5%	1/4W F
Q1504	8-729-119-76	TRANSISTOR 2SA1175-HFE		R1540	1-216-393-00	METAL OXIDE 2.2 5%	3W F
Q1505	8-729-017-05	TRANSISTOR 2SA1837		R1541	1-215-886-11	METAL OXIDE 100 5%	2W F
Q1506	8-729-017-06	TRANSISTOR 2SC4793		R1542	1-215-473-91	METAL OXIDE 150K 1%	1/4W
Q1701	8-729-119-78	TRANSISTOR 2SC2785-HFE		R1701	1-249-397-11	CARBON 22 5%	1/4W F
Q1702	8-729-119-78	TRANSISTOR 2SC2785-HFE		R1702	1-247-807-31	CARBON 100 5%	1/4W
Q1703	8-729-017-05	TRANSISTOR 2SA1837		R1703	1-249-416-11	CARBON 820 5%	1/4W
Q1704	8-729-119-78	TRANSISTOR 2SC2785-HFE		R1704	1-247-807-31	CARBON 100 5%	1/4W
Q1705	8-729-119-76	TRANSISTOR 2SA1175-HFE		R1706	1-247-815-91	CARBON 220 5%	1/4W
Q1706	8-729-017-06	TRANSISTOR 2SC4793		R1707	1-249-411-11	CARBON 330 5%	1/4W
Q1708	8-729-119-78	TRANSISTOR 2SC2785-HFE		R1708	1-249-417-11	CARBON 1K 5%	1/4W
Q1709	8-729-119-78	TRANSISTOR 2SC2785-HFE		R1710	1-249-403-11	CARBON 68 5%	1/4W
< RESISTOR >				R1711	1-249-403-11	CARBON 68 5%	1/4W
R1505	1-249-437-11	CARBON 47K 5%	1/4W	R1712	1-212-974-00	FUSIBLE 47 5%	1/2W F
R1506	1-249-421-11	CARBON 2.2K 5%	1/4W	R1713	1-249-386-11	CARBON 2.7 5%	1/4W F
R1507	1-247-843-11	CARBON 3.3K 5%	1/4W	R1714	1-249-414-11	CARBON 560 5%	1/4W F
R1508	1-249-421-11	CARBON 2.2K 5%	1/4W	R1715	1-249-432-11	CARBON 18K 5%	1/4W
				R1716	1-249-417-11	CARBON 1K 5%	1/4W F
				R1717	1-216-476-11	METAL OXIDE 180 5%	3W F
				R1718	1-249-432-11	CARBON 18K 5%	1/4W
				R1719	1-249-385-11	CARBON 2.2 5%	1/4W F
				R1720	1-247-696-11	CARBON 47 5%	1/4W F



The components identified by shading and marked Δ are critical for safety
Replace only with the part number specified.

REF.NO.	PART.NO	DESCRIPTION	REMARK
R1721	1-249-414-11	CARBON 560 5%	1/4W F
R1722	1-249-401-11	CARBON 47 5%	1/4W
R1723	1-535-465-11	LEAD, JUMPER (5.0MM)	
R1724	1-249-417-11	CARBON 1K 5%	1/4W
R1725	1-249-417-11	CARBON 1K 5%	1/4W
R1726	1-249-429-11	CARBON 10K 5%	1/4W
R1727	1-249-431-11	CARBON 15K 5%	1/4W
R1728	1-249-408-11	CARBON 180 5%	1/4W
R1729	1-249-408-11	CARBON 180 5%	1/4W
R1730	1-249-417-11	CARBON 1K 5%	1/4W
R1731	1-249-414-11	CARBON 560 5%	1/4W
R1806	1-247-883-00	CARBON 150K 5%	1/4W
R1807	1-249-429-11	CARBON 10K 5%	1/4W
R1808	1-249-429-11	CARBON 10K 5%	1/4W
R1809	1-249-429-11	CARBON 10K 5%	1/4W
R1810	1-249-429-11	CARBON 10K 5%	1/4W
*A-1646-183-A H Board, Complete			
	1-410-397-21	FERRITE 1.1UH	
< CAPACITOR >			
C5617	1-126-941-11	ELECT 470MF 20%	25V
C5621	1-136-165-00	FILM 0.1MF 5%	50V
C5623	1-104-666-11	ELECT 220MF 20%	25V
C5633 Δ	1-107-563-11	FILM 0.1MF 20%	300V
C5635 Δ	1-107-563-11	FILM 0.1MF 20%	300V
C5654	1-136-165-00	FILM 0.1MF 5%	50V
C5655	1-107-974-11	CERAMIC 47PF 5%	2KV
C5657	1-126-967-11	ELECT 47MF 20%	50V
C5658	1-107-679-91	ELECT 10MF 20%	400V
C5901	1-102-106-00	CERAMIC 100PF 10%	50V
C5902	1-137-372-11	FILM 0.022MF 5%	50V
C5903	1-137-372-11	FILM 0.022MF 5%	50V
C5904	1-104-665-11	ELECT 100MF 20%	25V
C5905	1-126-964-11	ELECT 10MF 20%	50V
C5907	1-126-964-11	ELECT 10MF 20%	50V
C5911	1-126-964-11	ELECT 10MF 20%	50V
C5913	1-102-106-00	CERAMIC 100PF 10%	50V
< CONNECTOR >			
CN5601 Δ	*1-580-844-11	PIN, CONNECTOR (POWER)	
CN5602 Δ	*1-691-291-11	PIN, CONNECTOR (PC BOARD) 5P	
CN5605	1-695-915-11	TAB (CONTACT)	
CN5900	1-694-564-11	TERMINAL BLOCK, S VHS	
CN5901	*1-568-882-51	PIN, CONNECTOR 7P VHS	
CN5903	*1-564-516-11	PLUG, CONNECTOR 13P	

REF.NO.	PART.NO	DESCRIPTION	REMARK
CN5916	1-568-878-51	PIN, CONNECTOR 3P	
< DIODE >			
D5639	8-719-923-42	DIODE MTZJ-T-77-6.2B	
D5640	8-719-063-72	DIODE D1NL20U-TA2	
D5642	8-719-510-53	DIODE D4SB60L	
D5901	8-719-030-11	DIODE SLA-570KT3F	
	*4-203-258-11	HOLDER, LED (D5901)	
D5906	8-719-109-89	DIODE RD5.6ESB2	
D5907	8-719-109-89	DIODE RD5.6ESB2	
D5910	8-719-923-60	DIODE MTZJ-T-77-9.1A	
< FUSE >			
F5601 Δ	1-576-232-21	FUSE (H.B.C.) 5A/250V	
	*1-533-725-11	HOLDER, FUSE (F601)	
< IC >			
IC5604	8-759-510-52	IC TEA7605	
IC5605	8-759-584-19	IC TNY253P	
IC5606 Δ	8-749-013-21	IC TLP721 (D4-G.)	
IC5900	8-742-014-11	HYB IC SBX1981-51	
< SOCKET >			
J5900	1-785-448-11	JACK	
< COIL >			
L5608	1-412-527-11	INDUCTOR 15UH	
L5901	1-408-603-31	INDUCTOR 10UH	
L5902	1-408-603-31	INDUCTOR 10UH	
L5903	1-408-603-31	INDUCTOR 10UH	
L5904	1-408-603-31	INDUCTOR 10UH	
< RESISTOR >			
R5602	1-249-389-11	CARBON 4.7 5%	1/4W F
R5629	1-260-135-11	CARBON 1M 5%	1/2W
R5630 Δ	1-205-998-11	RES, CEMENT 1 5%	10/W
R5641	1-249-417-11	CARBON 1K 5%	1/4W
R5653	1-215-863-11	METAL OXIDE 100 5%	1W F
R5900	1-247-815-91	CARBON 220 5%	1/4W
R5901	1-249-401-11	CARBON 47 5%	1/4W
R5904	1-249-389-11	CARBON 4.7 5%	1/4W F
R5910	1-249-422-11	CARBON 2.7K 5%	1/4W
R5911	1-249-426-11	CARBON 5.6K 5%	1/4W
R5912	1-249-429-11	CARBON 10K 5%	1/4W
R5913	1-247-863-91	CARBON 22K 5%	1/4W
R5914	1-249-437-11	CARBON 47K 5%	1/4W
R5919	1-249-437-11	CARBON 47K 5%	1/4W

The components identified by shading and marked Δ are critical for safety
 Replace only with the part number specified.

H

REF. NO.	PART.NO	DESCRIPTION	REMARK	REF. NO.	PART.NO	DESCRIPTION	REMARK
R5921	1-249-437-11	CARBON	47K 5% 1/4W	MISCELLANEOUS			
	< SWITCH >			Δ 1-416-769-11	COIL, DEMAGNETIC		
S5601	Δ 1-571-433-21	SWITCH, PUSH (AC POWER)		1-452-032-00	MAGNETIC, DISC: 10MM		
S5900	1-692-979-11	SWITCH, TACTILE		1-452-094-00	MAGNET, ROTATABLE DISK: 15MM		
S5901	1-692-979-11	SWITCH, TACTILE		Δ X-4560-158-1	TRANSFORMER ASSY, FLYBACK (NX-4404//U2B4)		
S5902	1-692-979-11	SWITCH, TACTILE		1-529-408-11	SPEAKER 4.2x24CM		
	< TRANSFORMER >			1-529-417-11	SPEAKER (8CM)		
LF5600	Δ 1-431-402-11	TRANSFORMER, LINE FILTER		Δ 1-571-433-21	SWITCH, PUSH (AC POWER)		
LF5601	Δ 1-431-402-11	TRANSFORMER, LINE FILTER		1-693-338-11	TUNER/VIF (AEP) (KV-32FX20A/32FX20D/32FX20E)		
T5602	Δ 1-433-925-11	TRANSFORMER, CONVERTER		1-693-340-11	TUNER/VIF (FR) (KV-32FX20B)		
	< VARISTOR >			1-693-339-11	TUNER/VIF (UK) (KV-32FX20U)		
VDR5601	Δ 1-801-073-31	VARISTOR ERZV14D471		Δ 1-783-083-11	CORD, POWER (WITH NOISE FILTER) (KV-32FX20A/32FX20B/KV-32FX20D/32FX20E)		
	Δ *4-374-846-01	COVER, CAPACITOR, CAP TYPE (VDR5601)		Δ 1-776-204-12	CORD, POWER (FILTER) (KV-32FX20U)		
				Δ 1-451-480-11	DEFLECTION YOKE (Y32RVC2)		
				Δ 8-453-011-11	NECK ASSY, NA299-M		
				Δ 8-735-054-05	PICTURE TUBE (W76LLZ060X) (SD-302)		
				1-452-896-11	COIL, NA ROTATION (RT200)		
				Δ 1-251-807-11	CAP ASSY, HIGH VOLTAGE		
				ACCESSORIES AND PACKAGING MATERIALS			
				4-204-789-42	MANUAL, INSTRUCTION (KV-32FX20A) (ITALIAN)		
				4-204-789-52	MANUAL, INSTRUCTION (KV-32FX20B) (FRENCH/GERMAN/ITALIAN/DUTCH)		
				4-204-789-12	MANUAL, INSTRUCTION (KV-32FX20D) (TURKISH/GERMAN/GREEK/ENGLISH)		
				4-204-789-72	MANUAL, INSTRUCTION (KV-32FX20E) (SPANISH/PORTUGUESE/FINNISH/DANISH/ NORWEIGIAN/SWEDISH)		
				4-204-789-61	MANUAL, INSTRUCTION (KV-32FX20U) (ENGLISH)		
				*4-204-378-02	INDIVIDUAL CARTON		
				*4-204-683-01	CUSHION (LOWER) (ASSY)		
				*4-204-682-01	CUSHION (UPPER) (ASSY)		
				*4-395-957-01	BAG, PROTECTION		
				REMOTE COMMANDER			
				1-418-476-11	REMOTE COMMANDER (RM-887)		